

ANOKA COUNTY MINNESOTA

CONSTRUCTION PLANS FOR TRAFFIC SIGNAL SYSTEM

C. R. 3 (COON RAPIDS BOULEVARD)
AT SPRINGBROOK DRIVE

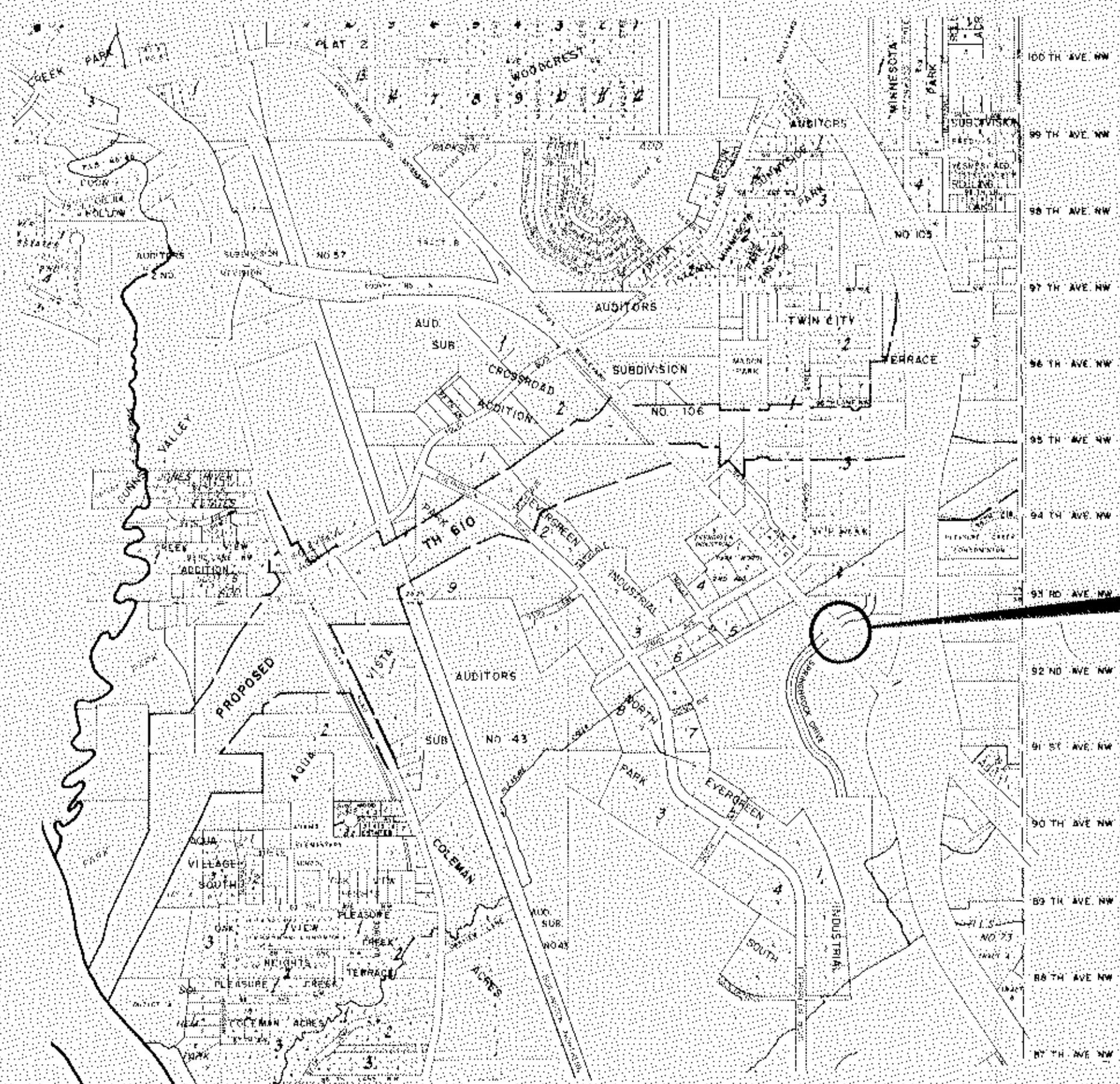
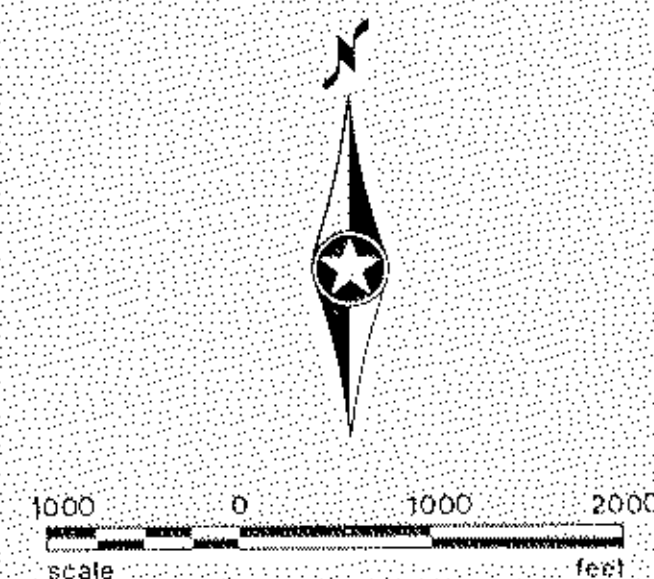

PROJECT LOCATION
S.A.P. 114-116-09
C.P. 87-07-03

COON RAPIDS, MINNESOTA

GOVERNING SPECIFICATIONS

THE 1983 EDITION OF THE MINNESOTA DEPARTMENT OF TRANSPORTATION "STANDARD SPECIFICATIONS FOR CONSTRUCTION" INCLUDING ALL SUPPLEMENTS, SHALL GOVERN.

INDEX OF SHEETS

- 1 TITLE SHEET
- 2 INTERSECTION LAYOUT
- 3 FIELD WIRING DIAGRAM
- 4 SIDEWALK AND MEDIAN
- 5 UTILITIES
- 6 DETAILS

THIS PLAN CONTAINS 6 SHEETS

Recommended for Approval _____
 Recommended for Approval _____
 Recommended for Approval *Paul K. Kinn*
 COUNTY ENGINEER
 Recommended for Approval *C. E. ... 9/1/87*
 DISTRICT STATE AID ENGINEER
 Recommended for Approval *... 9/4/87*
 APPROVED *11/1/87* _____
 DIRECTOR OFFICE OF STATE AID

ESTIMATED QUANTITIES

PROJECT NO.	ITEM NO.	ITEM	UNIT	TOTAL ESTIMATED QUANTITIES
	2104.501	REMOVE CONCRETE CURB AND GUTTER	LIN.FT.	200
	2104.505	REMOVE CONCRETE WALK	SQ. FT.	1050
	2521.501	4" CONCRETE WALK	SQ. FT.	840
	2531.501	CONCRETE CURB AND GUTTER (DES. B624)	LIN. FT.	200
	2531.602	PEDESTRIAN CURB RAMP	EACH	5
	2565.511	FULL-TRAFFIC-ACTUATED TRAFFIC CONTROL SIGNAL SYSTEM	SIGNAL SYSTEM	1

"ELECTRICAL ENGINEER CERTIFICATION"
 I hereby certify that this plan was prepared by me or under my direct supervision and that I am a duly Registered Professional Engineer under the laws of the State of Minnesota.

Date: _____ Reg. No. _____

SURVEY	CHECKED BY:	NO.	DATE	REVISIONS
DESIGN: M.K.	G.V.W.			
DRAWN: G.N.				

WE HEREBY CERTIFY THAT THIS PLAN WAS PREPARED BY ME OR UNDER MY DIRECT SUPERVISION AND THAT I AM A DULY REGISTERED PROFESSIONAL ENGINEER UNDER THE LAWS OF THE STATE OF MINNESOTA.

SEH REG. NO. 9089

SHORT-ELLIOTT-HENDRICKSON, INC
 Saint Paul, Minnesota • Chippewa Falls, Wisconsin

SIGNAL SYSTEM
 TITLE SHEET
 C. R. 3 (COON RAPIDS BOULEVARD)
 AT SPRINGBROOK DRIVE

C.P. 87-07-03
 S.A.P. 114-116-09

FILE NO. 87143	1
DATE: 7/31/87	6

NOTES:

- SEE SPECIAL PROVISIONS FOR CONTRACTORS RESPONSIBILITY FOR THE LOCATION OF UTILITIES.
- ALL SIGNAL FACES SHALL HAVE BACKGROUND SHIELDS.
- LUMINAIRES 3 AND 4 WITH P.E.C. AND CHECK SWITCH.
- SEE SPECIAL PROVISIONS FOR ANOKA COUNTY SERVICE CABINET DETAILS.
- DIRECTIONAL SIGNS TO BE INSTALLED ON MAST ARMS AT 1, 2, 3 AND 4. SEE SPECIAL PROVISIONS.
- ALL HANDHOLES WITH TYPE "C" COVERS.
- LOOP DETECTOR WIRES SHALL BE CROSS LINKED POLYETHYLENE (XLP) IN 1" N.M.C.. SEE DETAIL SHEET.
- ALL PEDESTRIAN INDICATIONS SHALL BE 12"x 12".
- SEE SPECIAL PROVISIONS FOR COUNTY FURNISHED EQUIPMENT.
- SEE SHEET 4 FOR SIDEWALK REVISIONS AND MEDIAN DETAILS.

3 TYPE P100-A-40-D40-9
P100 POLE FOUNDATION
TWO-ONE WAY SIGNALS-OVERHEAD
TYPE 20C-POLE MOUNTED 270°
LUMINAIRE-200W H.P.S. (APPROX.350°)
TWO-PEDESTRIAN PUSH BUTTONS AND SIGNS
TWO STEEL GUARD POSTS
EXTEND INTO H.H. 4:
3" R.S.C.
2- 12/C #12
1- 3/C #12
4- 1/C #10

2 TYPE 1A
PEDESTAL FOUNDATION
R10-10L SIGN AND DOWNLIGHT
PEDESTRIAN PUSH BUTTON AND SIGN
4-STEEL GUARD POSTS
(SEE MEDIAN DETAIL, SHEET 4)
EXTEND INTO H.H. 5:
3" R.S.C.
1- 12/C #12
1- 3/C #12

SIGNAL INDICATIONS

FACE	PHASE	FLASH	R	Y	G	RLTA	YLTA	GLTA
1-1	1	R				12	12	12
2-1	2	R	12	12	12			
2-2	2	R	12	12	12			
2-3	2	R	12	12	12			
4-1	4	R	12	12	12			
4-2	4	R	12	12	12			
4-3	4	R	12	12	12			
5-1	5	R				12	12	12
6-1	6	R	12	12	12			
6-2	6	R	12	12	12			
6-3	6	R	12	12	12			
8-1	8	R	12	12	12			
8-2	8	R	12	12	12			
8-3	8	R	12	12	12			

NOTE: ALL DIMENSIONS SHOWN ARE IN INCHES

4 TYPE P90-A-30-D40-9
P90 POLE FOUNDATION
ONE WAY SIGNAL-OVERHEAD
TYPE 10C-POLE MOUNTED 270°
LUMINAIRE-200W H.P.S. (APPROX. 350°)
TWO-PEDESTRIAN PUSH BUTTONS AND SIGNS
TWO STEEL GUARD POSTS
EXTEND INTO H.H. 9:
3" R.S.C.
2- 12/C #12
1- 3/C #12
4- 1/C #10

A SERVICE CABINET
CABINET FOUNDATION
EXTEND INTO H.H. 16:
2" R.S.C. WITH NYLON CHORD
EXTEND INTO H.H. 1:
METERED SIGNAL SERVICE
1 1/4" R.S.C.
3- 1/C #6
UNMETERED STREET LIGHTING SERVICE
1" R.S.C.
4- 1/C #10

B CONTROLLER & CABINET
CABINET FOUNDATION
EXTEND INTO H.H. 1:
4" R.S.C.
5- 12/C #12
3- 3/C #12
5- 2/C #14
METERED SIGNAL SERVICE
1 1/4" R.S.C.
3- 1/C #6
EXTEND INTO H.H.9:
4" R.S.C.
5- 12/C #12
3- 3/C #12
5- 2/C #14
BETWEEN H.H.1 AND H.H.9:
2" R.S.C.
2- 1/C #10

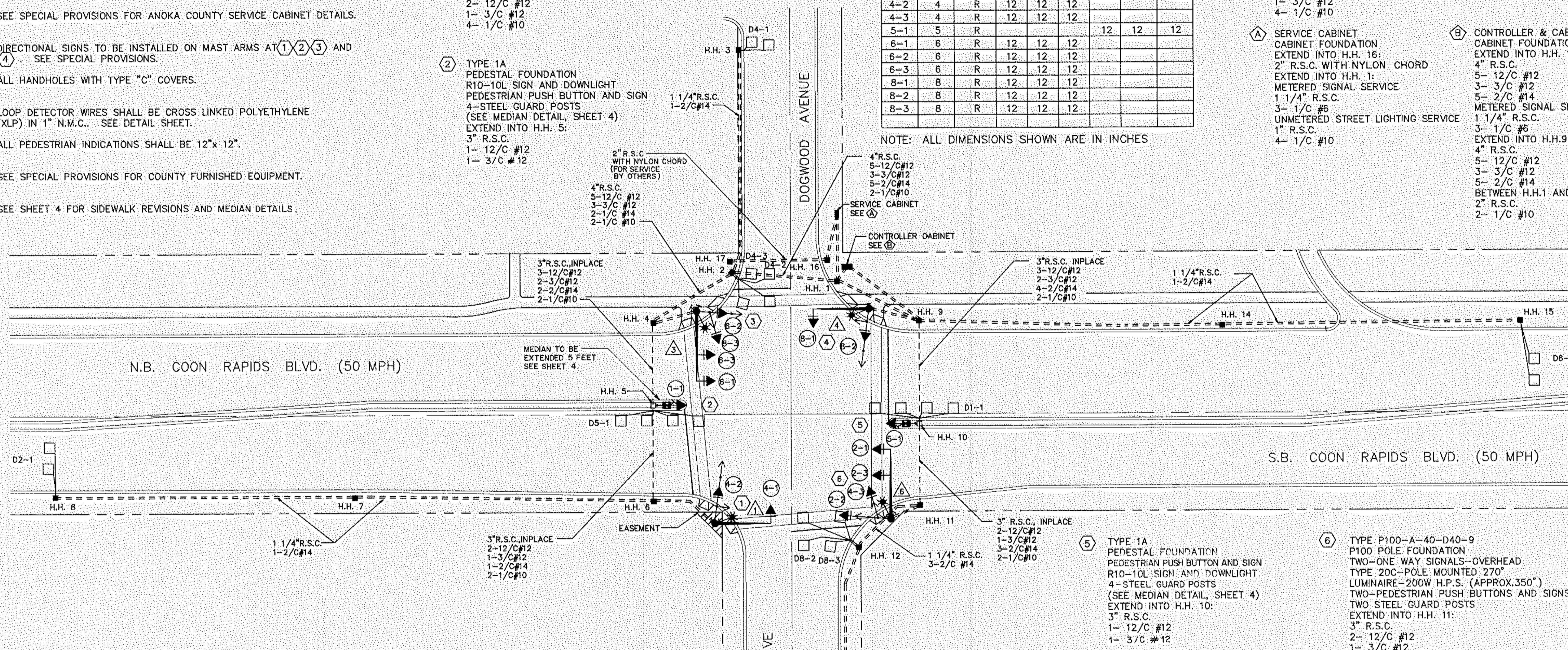
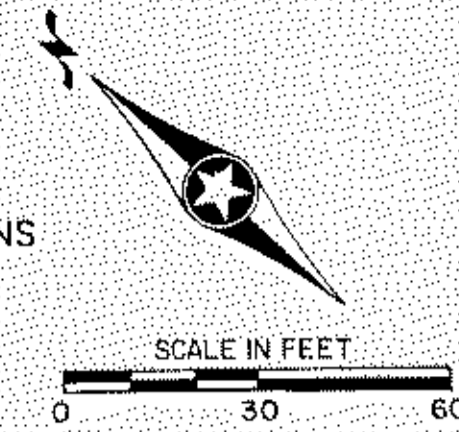

LOOP DETECTORS

NUMBER	SIZE	LOCATION	FUNCTION
D1-1	MULTIPLE	----	1
D2-1	2-6'x6'	370'	1
D4-1	2-6'x6'	140'	3,8
D4-2	2-6'x6'	----	1
D4-3	2-6'x6'	----	7
D5-1	MULTIPLE	----	1
D6-1	2-6'x6'	370'	1
D8-1	2-6'x6'	140'	3,8
D8-2	2-6'x6'	----	1
D8-3	2-6'x6'	----	7

- FUNCTIONS:**
- CALL AND EXTEND
 - CALL ONLY
 - EXTEND ONLY
 - CALL ONLY DENSITY
 - DELAYED CALL ONLY
 - DELAYED CALL ONLY DENSITY
 - DELAYED CALL - IMMEDIATE EXTEND
 - CARRY OVER (STRETCH)
 - ADVISORY DETECTOR
 - SAMPLING DETECTOR
 - SPECIAL DETECTOR

1 TYPE P90-A-30-D40-9
P90 POLE FOUNDATION
ONE WAY SIGNAL-OVERHEAD
TYPE 10C-POLE MOUNTED 270°
LUMINAIRE-200W H.P.S. (APPROX.350°)
TWO-PEDESTRIAN PUSH BUTTONS & SIGNS
TWO STEEL GUARD POSTS
EXTEND INTO H.H. 6:
3" R.S.C.
2- 12/C #12
1- 3/C #12
2- 1/C #10

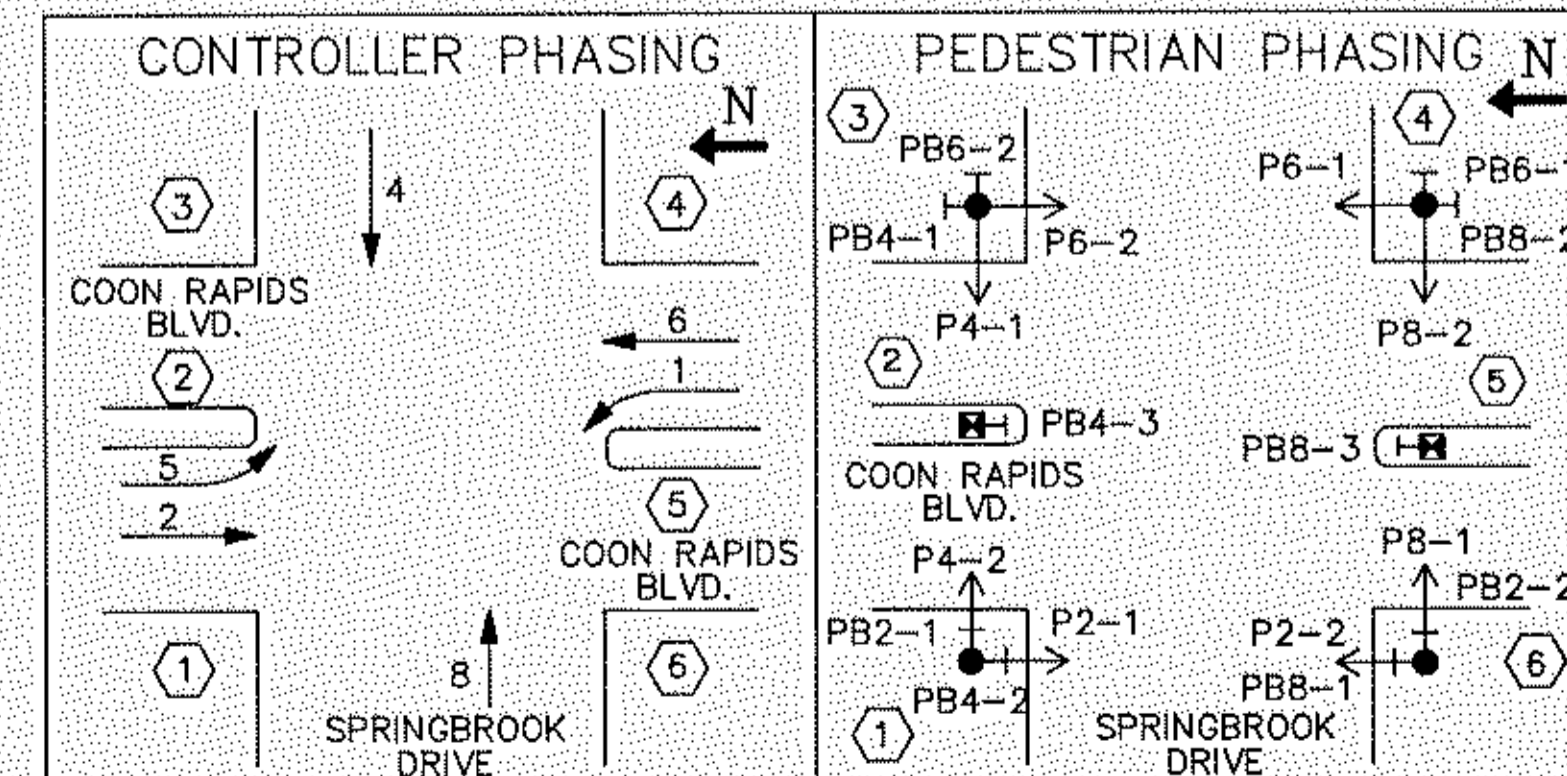

SURVEY:	CHECKED BY:	NO.	DATE	REVISIONS	I hereby certify that this plan was prepared by me or under my direct supervision and that I am a duly Registered Professional Engineer under the laws of the State of Minnesota.
DESIGN: M.K.	G.V.W.				Date: _____
DRAWN: CAD					Proj. No. 8089

SHORT-ELLIOTT-HENDRICKSON, INC.
Saint Paul, Minnesota • Chippewa Falls, Wisconsin

SIGNAL SYSTEM INTERSECTION LAYOUT
CR. 3 (COON RAPIDS BOULEVARD)
AT SPRINGBROOK DRIVE

C.P. 87-07-03	FILE NO.:	2
S.A.P. 114-116-09	87143	
	DATE:	7/31/87
		6

CONTROLLER AND CABINET

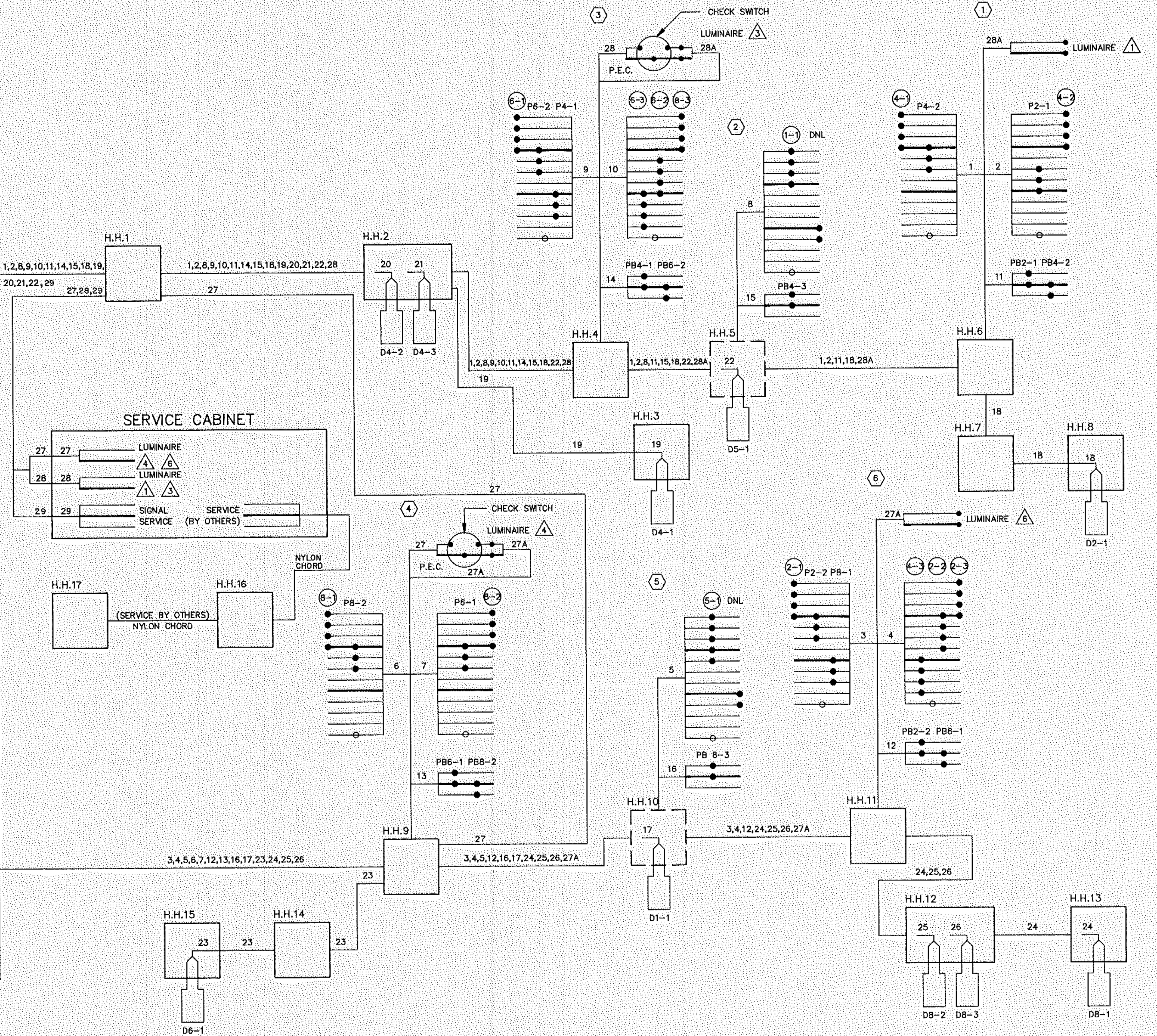
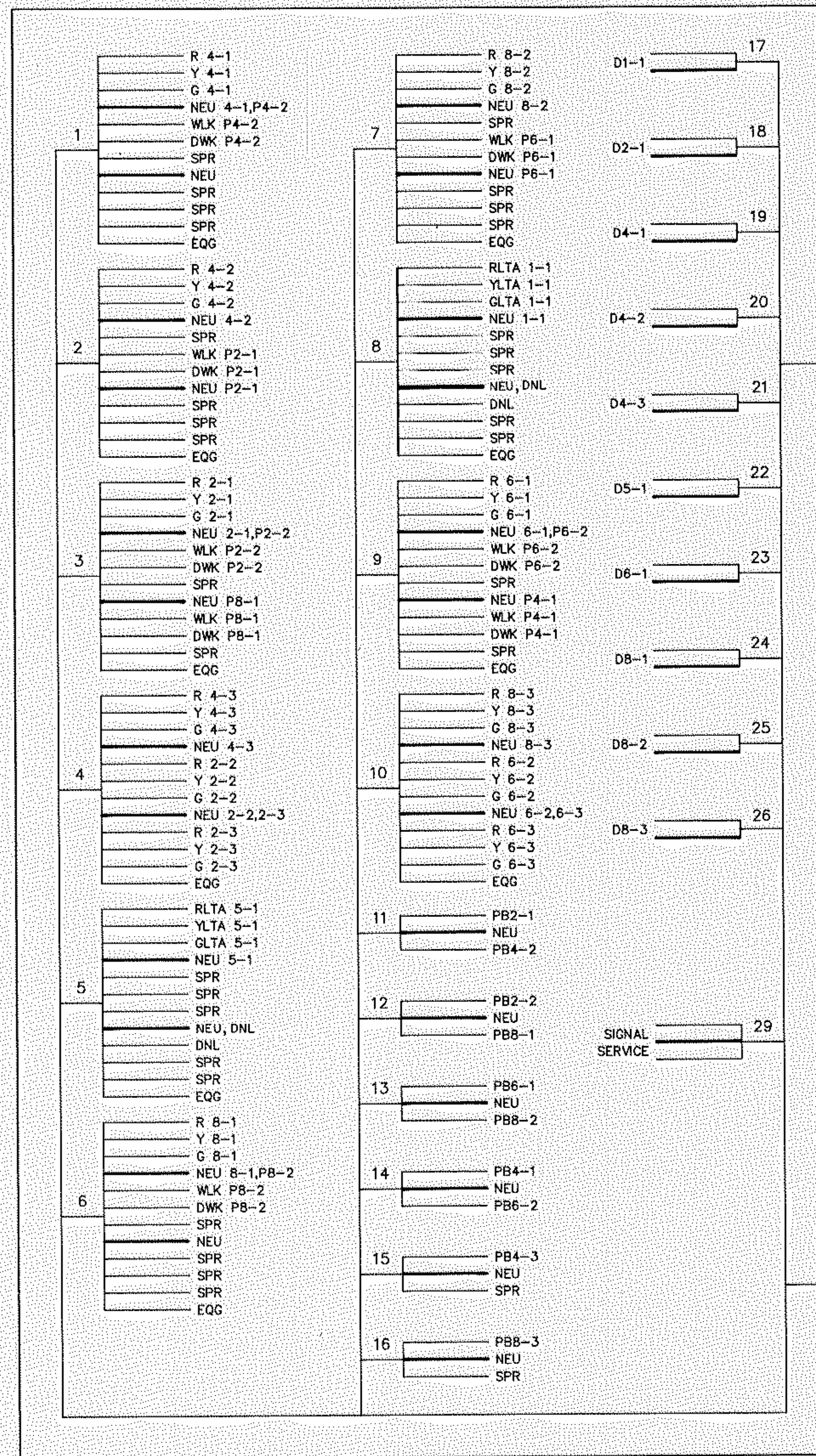

SURVEY:	CHECKED BY:	NO.	DATE	REVISIONS	I hereby certify that this plan was prepared by me or under my direct supervision and that I am a duly Registered Professional Engineer under the laws of the State of Minnesota. Date: _____ Reg. No. 9089
DESIGN: M.K.	G.V.W				
DRAWN: CAD					

SHORT-ELLIOTT-HENDRICKSON, INC.
Saint Paul, Minnesota • Chippewa Falls, Wisconsin

SIGNAL SYSTEM
WIRING DIAGRAM
CR 3 (COON RAPIDS BOULEVARD)
AT SPRINGBROOK DRIVE

C.P. 87-07-03
S.A.P. 114-116-09

FILE NO.:	87143	3
DATE:	7/31/87	
		6

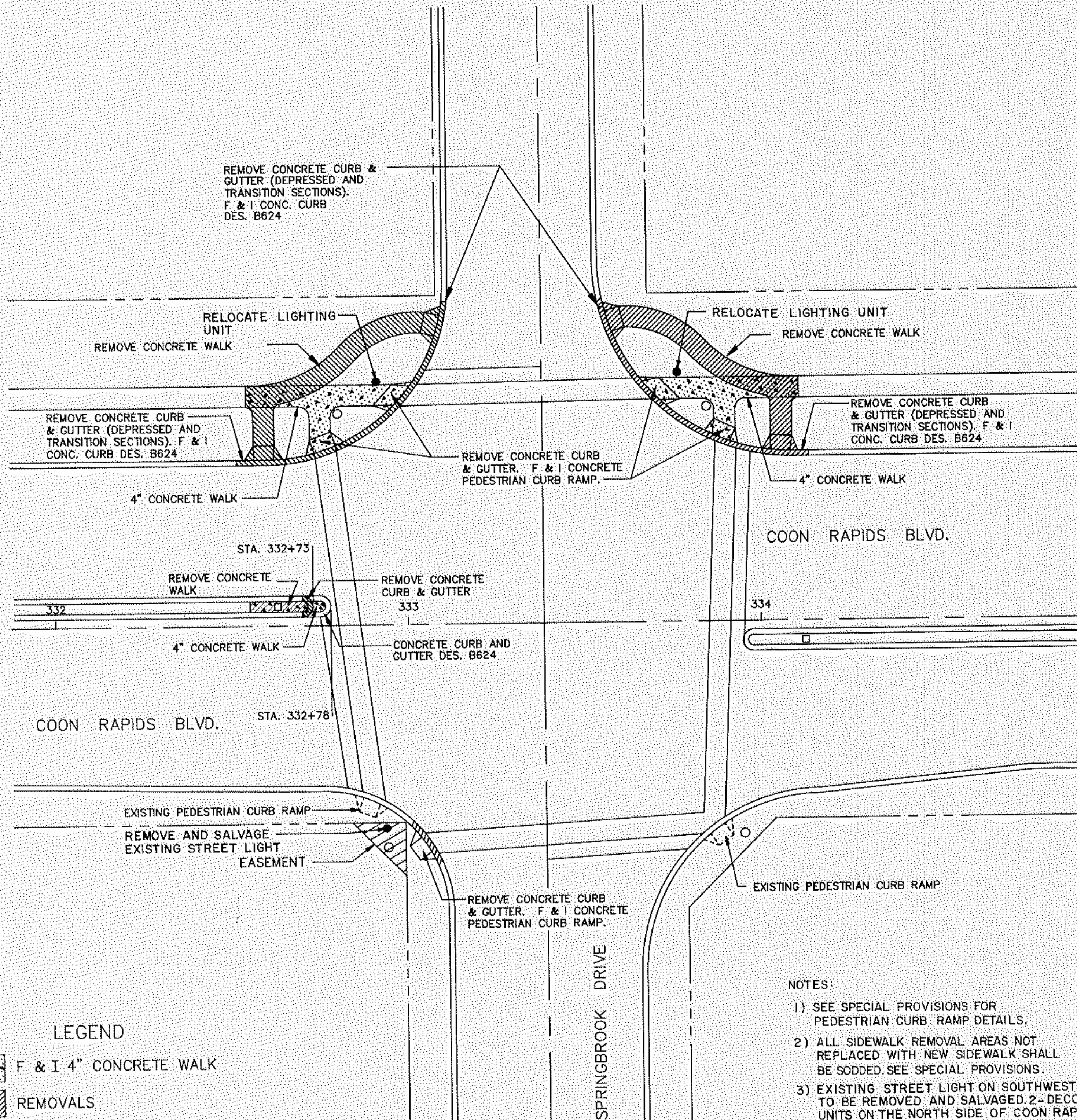
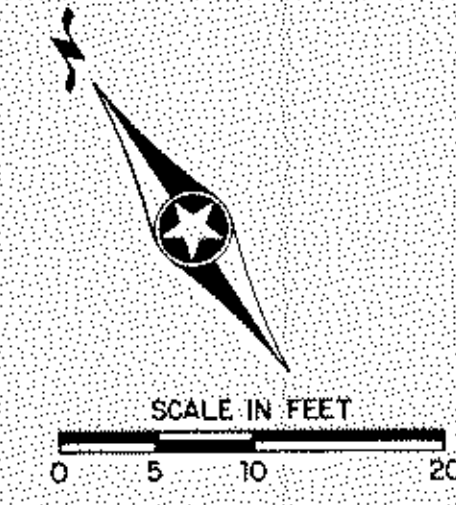

- LEGEND**
- F & I 4" CONCRETE WALK
 - REMOVALS
 - SIGNAL MAST ARM POLE LOCATIONS

- NOTE:**
- 1) ALL CONCRETE WALK (EXCEPT IN MEDIAN NOSE) SHALL BE SIX FEET IN WIDTH.
 - 2) CORNER RADII AT SIDEWALK INTERSECTIONS SHALL BE THREE FEET.

- NOTES:**
- 1) SEE SPECIAL PROVISIONS FOR PEDESTRIAN CURB RAMP DETAILS.
 - 2) ALL SIDEWALK REMOVAL AREAS NOT REPLACED WITH NEW SIDEWALK SHALL BE SODDED. SEE SPECIAL PROVISIONS.
 - 3) EXISTING STREET LIGHT ON SOUTHWEST CORNER TO BE REMOVED AND SALVAGED. 2-DECORATIVE LIGHTING UNITS ON THE NORTH SIDE OF COON RAPIDS BOULEVARD TO BE RELOCATED AS DIRECTED BY THE ENGINEER. SEE SPECIAL PROVISIONS.

MEDIAN NOSE DETAIL
(NO SCALE)

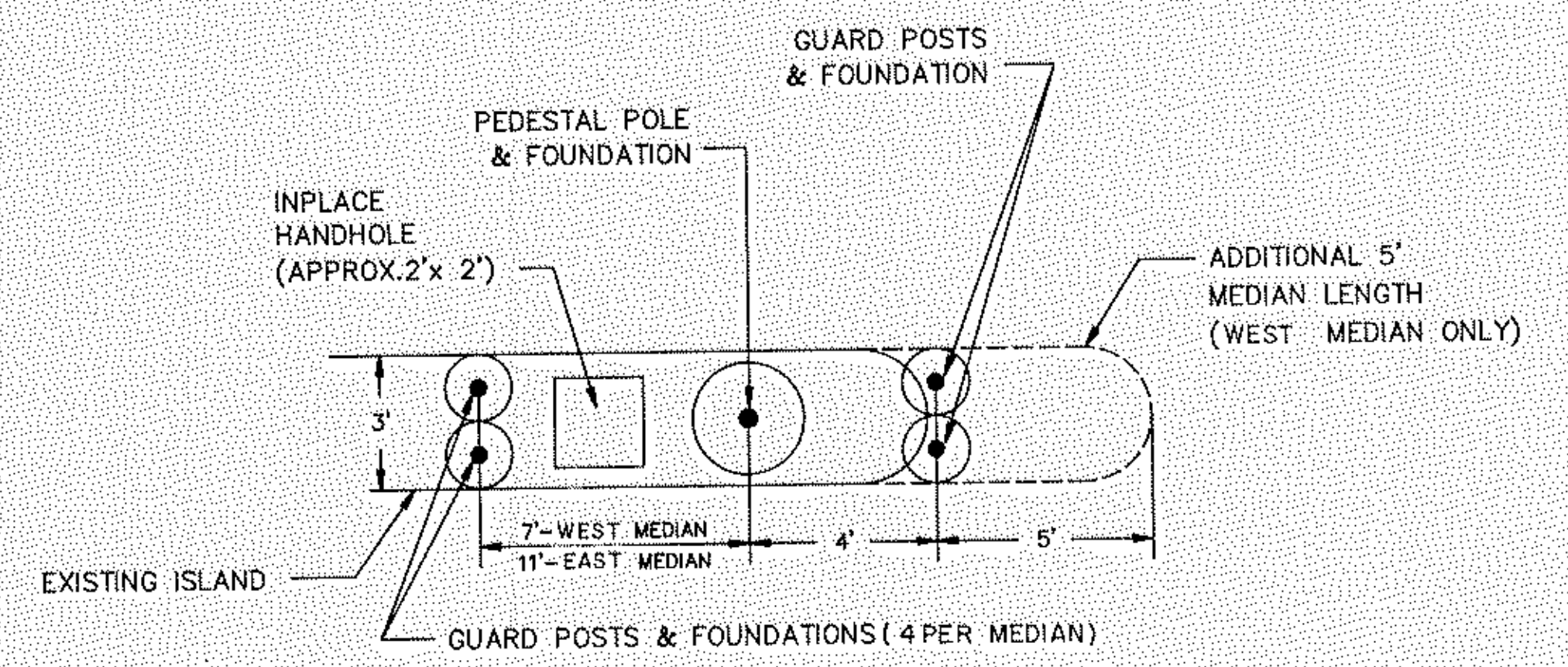

SURVEY:	CHECKED BY:	NO.	DATE	REVISIONS
DESIGN: M.K.	G.V.W.			
DRAWN: CAD				

I hereby certify that this plan was prepared by me or under my direct supervision and that I am a duly Registered Professional Engineer under the laws of the State of Minnesota.
Date: _____ Reg. No. 9089

SHORT-ELLIOTT-HENDRICKSON, INC.
Saint Paul, Minnesota • Chippewa Falls, Wisconsin

SIDEWALK AND MEDIAN
GR. 3 (COON RAPIDS BOULEVARD)
AT SPRINGBROOK DRIVE

C.P. 87-07-03
S.A.P. 114-116-09

FILE NO.:	87143	4
DATE:	7/31/87	6

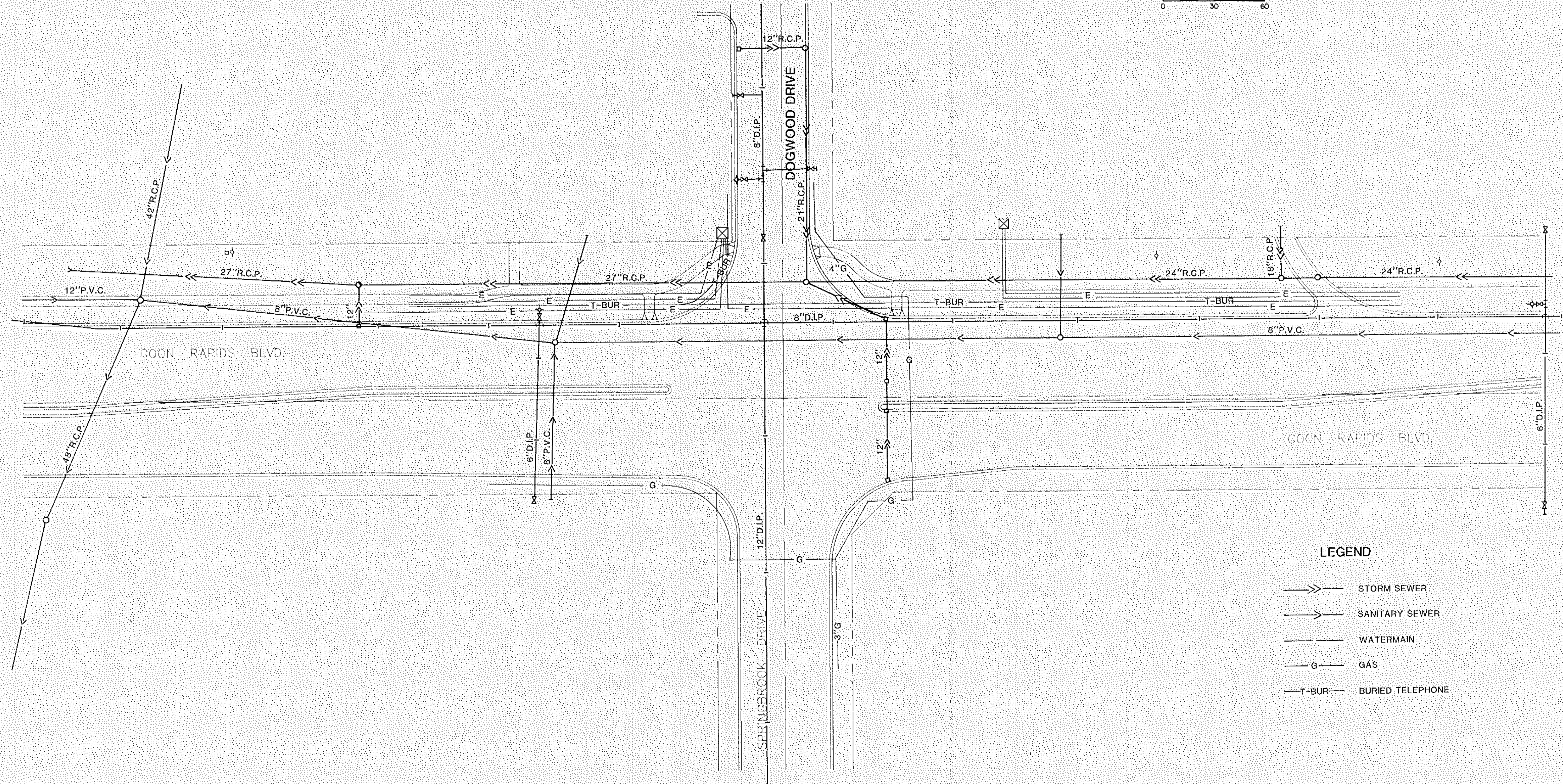
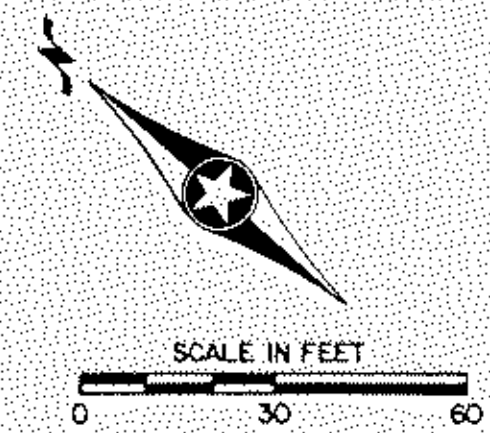

LEGEND

- >>— STORM SEWER
- >— SANITARY SEWER
- — — WATERMAIN
- G — GAS
- T-BUR — BURIED TELEPHONE

SURVEY:	CHECKED BY:	NO.	DATE	REVISIONS	I hereby certify that this plan was prepared by me or under my direct supervision and that I am a duly Registered Professional Engineer under the laws of the State of Minnesota. Date: 7/31/87 Reg. No. 0689
DESIGN: M.K.	G.V.W.				
DRAWN: G.N.					

SHORT-ELLIOTT-HENDRICKSON, INC.
Saint Paul, Minnesota • Chippewa Falls, Wisconsin

SIGNAL SYSTEM
UTILITIES
C.R. 3 (COON RAPIDS BOULEVARD)
AT SPRINGBROOK DRIVE

C.P. 87-07-03
S.A.P. 114-116-09

FILE NO.:	87143	5
DATE:	7/31/87	6

LOOP DETECTOR DETAIL "C"

PLAN VIEW
(NOT TO SCALE)

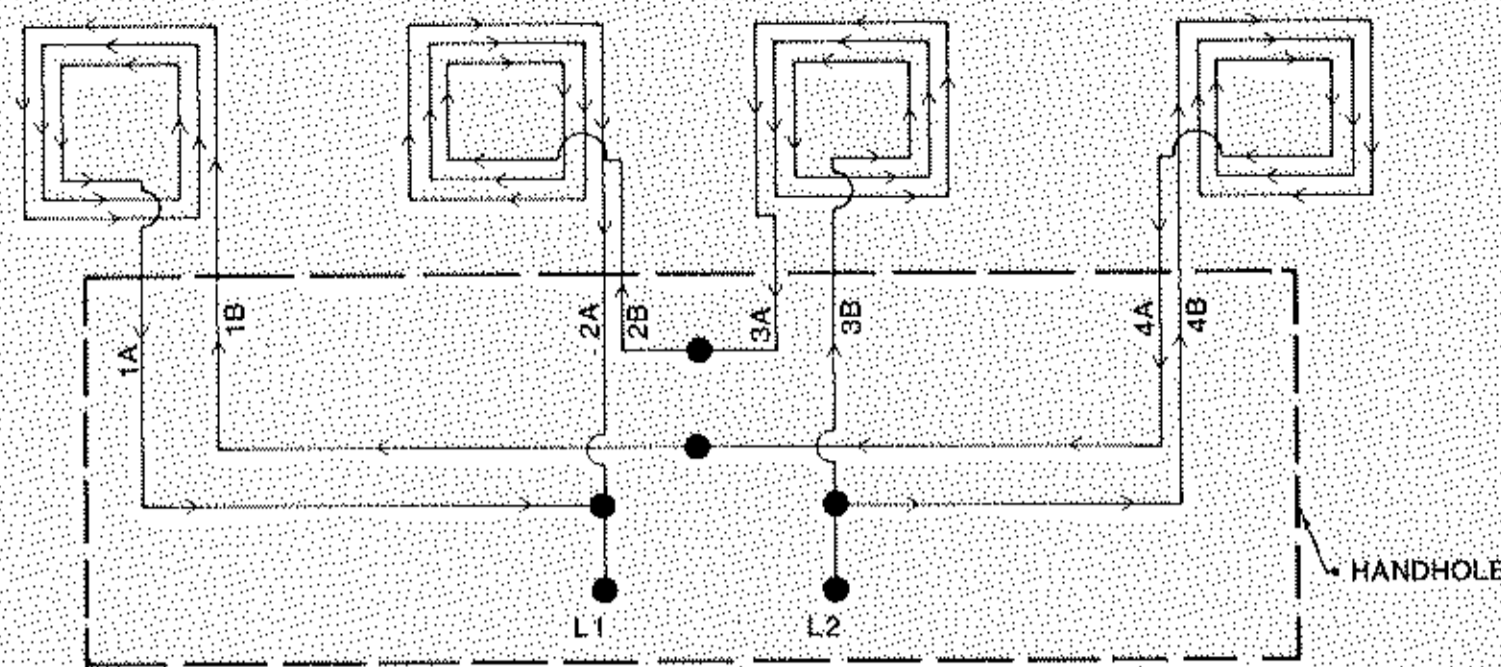

LOOP CONNECTIONS SHALL BE SPLICED IN THE HANDHOLE AS FOLLOWS:
1B TO 4A 2B TO 3A 1A AND 2A TO L1 3B AND 4B TO L2.
SPLICE CONTROL CABLE TO L1 AND L2 IN HANDHOLE.
ALL CONDUCTORS SHALL BE TAGGED IN HANDHOLE (1A, 1B, ect.).

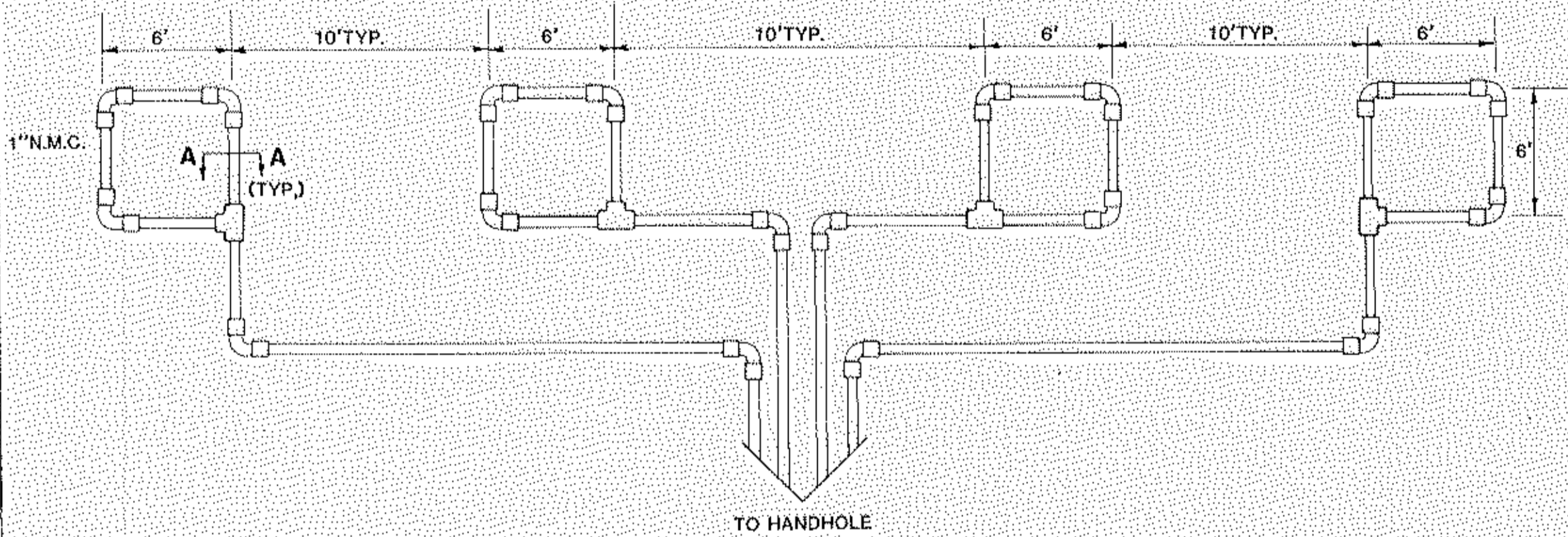

- NOTES:
- 1) ALL CORNERS SHALL BE STANDARD 90° CONDUIT BENDS.
 - 2) CONNECT WIRES IN HANDHOLES USING WESTERN UNION SPLICE, SOLDERED, TAPED & AND WATERPROOFED.
 - 3) LOOP DETECTOR WIRES SHALL BE CROSS LINKED POLYETHYLENE (XLP) SEE SPECIAL PROVISIONS.
 - 4) LOOP WIRES SHALL BE TWISTED A MINIMUM OF 1 TURN PER 3 FEET FROM THE LOOP TO THE CONDUIT TO AND 3 TURNS PER FOOT THROUGH THE CONDUIT THE HANDHOLE.
 - 5) N.M.C. DESIGNATES NON-METALLIC CONDUIT (SPEC 3803).

LOOP DETECTOR DETAIL "A"

PLAN VIEW
(NOT TO SCALE)

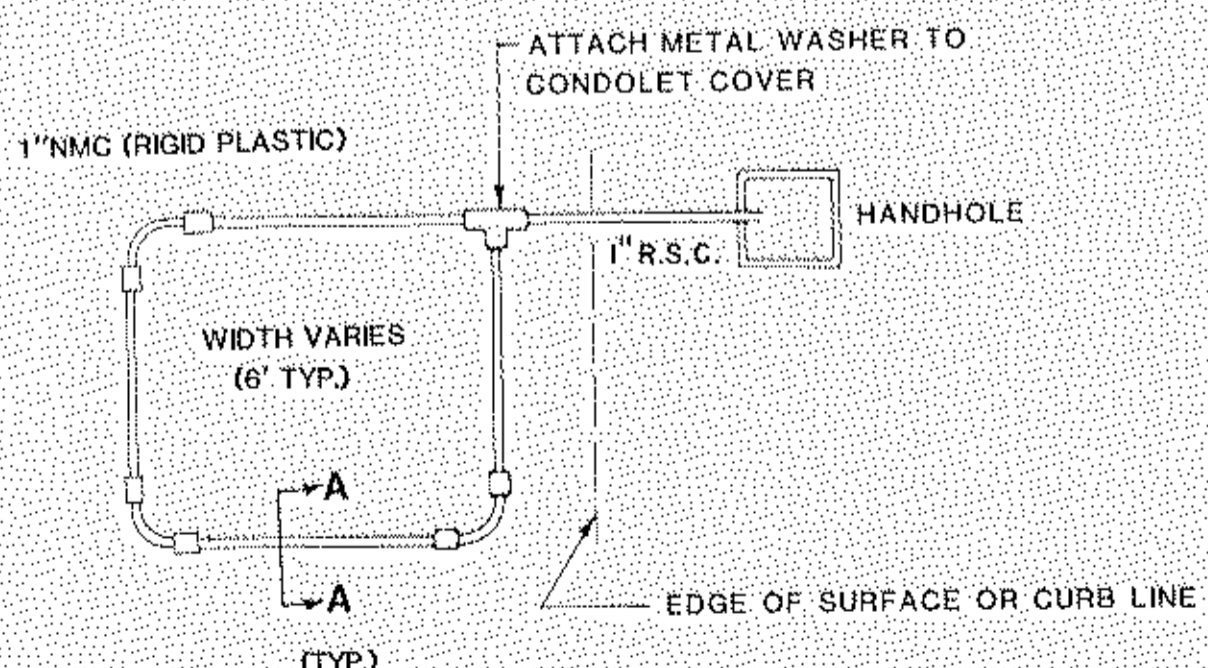

DRAINAGE DETAILS

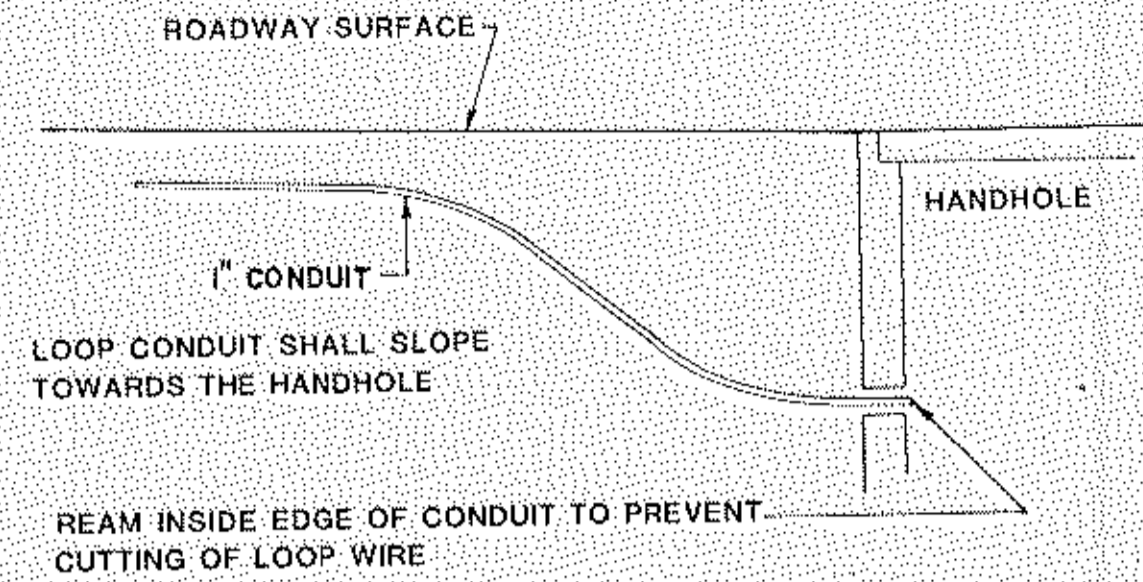

CROSS SECTION A-A

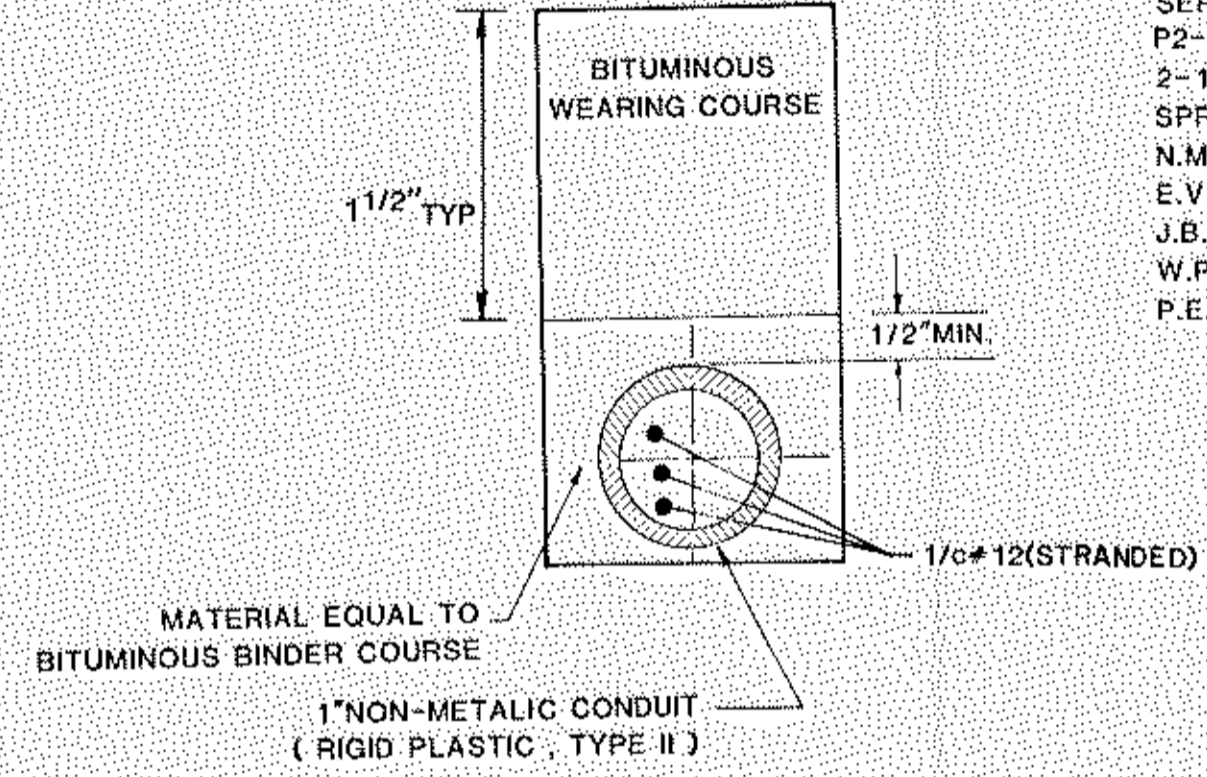

CONDUIT INSTALLATION DETAIL FOR LOOP DETECTORS

LOOP DETECTOR CONDUITS ARE TO BE INSTALLED IN 3" CUT TRENCHES AS SHOWN ON PLANS. INSTALL EACH COMPLETE DETECTOR ASSEMBLY WITH THE DETECTOR WIRE PULLED THROUGH THE COMPLETE ASSEMBLY TO HANDHOLE WHERE APPROPRIATE, PLACE DETECTOR CONDUIT IN BITUMINOUS BINDER COURSE PRIOR TO PLACEMENT OF THE WEARING COURSE. THE DEPTH OF THE TRENCH AND THE RESULTANT PLACEMENT OF THE DETECTOR CONDUIT SHALL BE SUCH THAT THE ENTIRE DETECTOR ASSEMBLY DRAINS INTO THE HANDHOLE. BACKFILL AND COMPACT THE TRENCHES WITH MATERIAL EQUIVALENT TO THE MATERIAL REMOVED.

LOOP DETECTOR DETAIL "B"

PLAN VIEW
(NOT TO SCALE)
(TYPICAL)

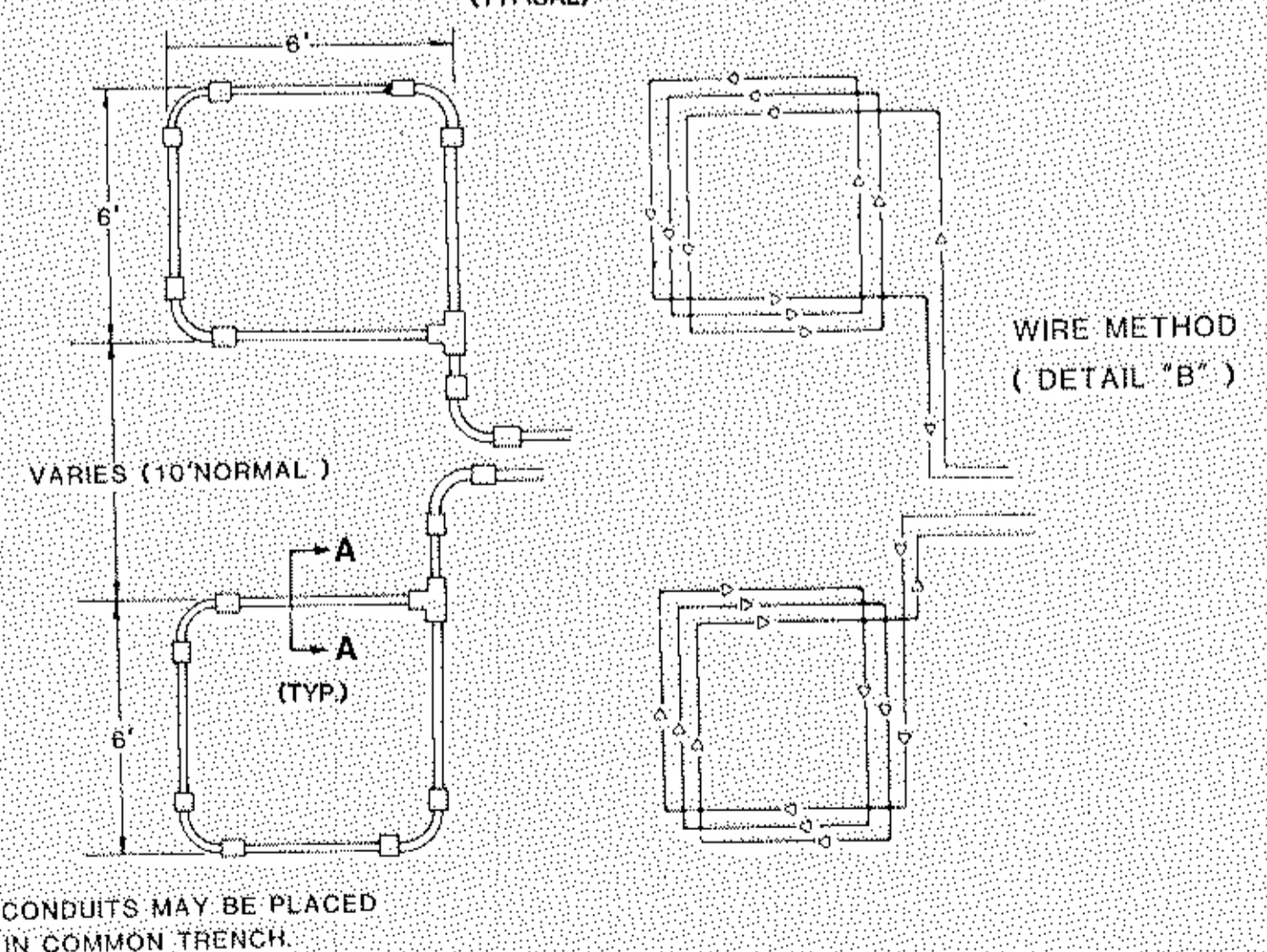

ABBREVIATIONS

- EQUIPMENT AND INDICATIONS**
- R, RED - RED
 - Y, YEL - YELLOW
 - G, GRN - GREEN
 - WLK - WALK
 - NEU - NEUTRAL
 - DWK - DON'T WALK
 - LUM - LUMINAIRE
 - DNL - DOWNLIGHT
 - H.H. - HANDHOLE
 - EQG - EQUIPMENT GROUND
 - R.S.C. - RIGID STEEL CONDUIT
 - GLTA - GREEN LEFT TURN ARROW
 - YRTA - YELLOW RIGHT TURN ARROW
 - D2-1(eg) - DETECTOR-PHASE "2"
 - GR.R - GROUND ROD
 - SER. - SERVICE
 - P2-2 - PEDESTRIAN INDICATIONS - PHASE "2"
 - 2-1(eg) - SIGNAL HEADS - PHASE "2"
 - SPR. - SPARE CONDUCTORS
 - N.M.C. - NON METALLIC CONDUIT
 - E.V.P. - EMERGENCY VEHICLE PRE-EMPTION
 - J.B. - JUNCTION BOX
 - W.P. - WOOD POLE
 - P.E.C. - PHOTOELECTRIC CELL

CONDUCTOR COLOR CODE

- R - RED
- O - ORANGE
- BL - BLUE
- WH - WHITE
- G - GREEN
- BLK - BLACK
- R/BLK - RED WITH BLACK TRACER
- O/BLK - ORANGE WITH BLACK TRACER
- BL/BLK - BLUE WITH BLACK TRACER
- WH/BLK - WHITE WITH BLACK TRACER
- BLK/WH - BLACK WITH WHITE TRACER
- G/BLK - GREEN WITH BLACK TRACER

CONDUCTOR COLOR CODING

R	BLK	2-1/C#6
O	WH	2-1/C#10
BL	R	
WH	W	3/C#12
R/BLK	BLK	
O/BLK	BLK	2/C#14
BL/BLK	CLEAR	
BLK	R OR O	
BLK/WH	WH OR YEL	3/C#20
G/BLK	BLK OR BL	
G		

NOTE: ALL TERMINAL BLOCK CONNECTIONS SHALL BE ARRANGED AS SPECIFIED ABOVE

LEGEND OF SYMBOLS

CONTROLLER AND SERVICE EOPT. NO'S	(Symbol)
SIGNAL BASE NO.	(Symbol)
SIGNAL FACE NO.	(Symbol)
LUMINAIRE NO.	(Symbol)
CONTROLLER AND CABINET	(Symbol)
CONTROLLER AND CABINET-IN PLACE	(Symbol)
HANDHOLE	(Symbol)
HANDHOLE-IN PLACE	(Symbol)
RIGID STEEL CONDUIT (R.S.C.)	(Symbol)
RIGID STEEL CONDUIT (R.S.C.)-IN PLACE	(Symbol)
SIGNAL FACE WITH BACKGROUND SHIELD	(Symbol)
SIGNAL FACE W/O BACKGROUND SHIELD	(Symbol)
SIGNAL FACE-IN PLACE	(Symbol)
PEDESTRIAN INDICATIONS	(Symbol)
PEDESTRIAN INDICATIONS-IN PLACE	(Symbol)
PEDESTRIAN PUSH BUTTON ON PEDESTAL OR POLE	(Symbol)
PEDESTRIAN PUSH BUTTON STATION	(Symbol)
TRAFFIC SIGNAL PEDESTAL	(Symbol)
TRAFFIC SIGNAL PEDESTAL-IN PLACE	(Symbol)
TRAFFIC SIGNAL POLE AND MAST ARM	(Symbol)
TRAFFIC SIGNAL POLE AND MAST ARM-IN PLACE	(Symbol)
STREET LIGHT POLE AND LUMINAIRE	(Symbol)
STREET LIGHT POLE AND LUMINAIRE-IN PLACE	(Symbol)
MAST ARM AND LUMINAIRE	(Symbol)
MAST ARM AND LUMINAIRE-IN PLACE	(Symbol)
WOOD POLE	(Symbol)
WOOD POLE-IN PLACE	(Symbol)
SOURCE OF POWER	(Symbol)
RAILROAD SIGNAL-IN PLACE	(Symbol)
RIGHT OF WAY LINE	(Symbol)
CENTER LINE	(Symbol)
EDGE OF ROADWAY	(Symbol)
SHOULDER LINE	(Symbol)
CURB LINE	(Symbol)
STOP BAR	(Symbol)
CROSSWALK	(Symbol)

STANDARD PLATES

PLATE NO.	DESCRIPTION
* 8110 C	TRAFFIC SIGNAL BRACKETING - POLE MOUNTED
* 8111 B	TRAFFIC SIGNAL BRACKETING - PEDESTAL MOUNTED
* 8112 C	PEDESTAL FOUNDATION
8113 C	MAGNETIC VEHICLE DETECTOR INSTALLATION
* 8115 C	PEDESTRIAN PUSH BUT ON INSTALLATION
* 8116 C	STEEL GUARD POST
* 8117 F	PRECAST CONCRETE HANDHOLE
8118 C	SERVICE EQUIPMENT AND POLE
* 8119 C	GROUND MOUNTED CABINET FOUNDATION
* 8120 H	P-80 AND P-90 POLE FOUNDATION
* 8121 B	TRANSFORMER BASE WITH POLE BASE PLATE
* 8122 C	PEDESTAL AND PEDESTAL BASE
* 8123 B	POLE AND MAST ARM
* 8124 D	SIGNAL HEAD MOUNTS
8125 A	SWING-AWAY HINGE
* 8126 C	P-100 POLE FOUNDATION
8130 D	SAW CUT LOOP DETECTORS
* 7035 J	CONCRETE WALK AND CURB

* THESE STANDARD PLATES APPLY TO THIS PLAN

SURVEY	CHECKED BY:	NO.	DATE	REVISIONS	I hereby certify that this plan was prepared by me or under my direct supervision and that I am a duly Registered Professional Engineer under the laws of the State of Minnesota. Date: _____ Reg. No. 9089
DESIGN M.K.	G.V.W.				
DRAWN G.N.					

SEH SHORT-ELLIOTT-HENDRICKSON, INC.
Saint Paul, Minnesota • Chippewa Falls, Wisconsin

SIGNAL SYSTEM
DETAILS
C.O. 3 (COON RAPIDS BOULEVARD)
AT SPRINGBROOK DRIVE

C.P. 87-07-03
S.A.P. 114-116-09

FILE NO.	6
87143	
DATE	6
7/31/87	