



Anoka County

MINNESOTA

Respectful, Innovative, Fiscally Responsible

ANOKA COUNTY TRANSPORTATION DIVISION

1440 BUNKER LAKE BLVD NW

ANDOVER, MN 55304

763-324-3176

highwaypermits@anokacountymn.gov

PERMIT NUMBER

24-452

RIGHT OF WAY

COMMERCIAL ACCESS

CR 68

APPLICATION FOR PERMIT FOR INSTALLATION OF UTILITIES OR PLACING OBSTRUCTIONS ON THE COUNTY HIGHWAY SYSTEM
ALL APPLICANTS MUST BE REGISTERED PRIOR TO PERMIT APPROVAL

APPLICANT NAME Arnt Construction Company Inc.

CONTACT PERSON Nicholas J Arnt

ADDRESS PO Box 549

CITY Hugo, MN 55038

PHONE NUMBER 651-426-1296

EMAIL narnt@arntco.com

COMPANY OR INDIVIDUAL PERFORMING WORK Arnt Construction Company Inc.

CONTACT PERSON Nicholas J Arnt

EMAIL narnt@arntco.com

PHONE NUMBER 651-426-1296

PERMIT WORK TO START 07/25/2024

PERMIT WORK TO BE COMPLETED 10/31/2024

DURATION OF JOB 3 Months

ARE YOU BEING ASKED TO RELOCATE DUE TO A COUNTY PROJECT? No

ANOKA COUNTY PROJECT NUMBER

WORK SITE ADDRESS 2506 Swedish Drive NE

CITY Ham Lake

METHOD OF INSTALLATION/CONSTRUCTION Construction, Grade, pave, striping

NATURE OF WORK Construct a Though Lane, NB left turn lane and a Right Turn Lane

PER APPROVED PLAN ON FILE AT ACHD

SURFACE TO BE DISTURBED

SITE PLAN

IF THE ROADWAY IS ENCROACHED, YOU MUST ATTACH A TRAFFIC CONTROL PLAN AND/OR REFERENCE THE MOST CURRENT VERSION OF THE MN TEMPORARY TRAFFIC CONTROL FIELD MANUAL (3+ DAYS REQUIRES PLANS TO BE SIGNED BY A LICENSED PE).

DITCH/BLVD



See attached

GRAVEL



X BITUMINOUS

CONCRETE

NONE

IS SIGNING AND STRIPING REQUIRED? Yes

DEPTH FROM SURFACE 10 Inches

(60" minimum under county roads)

SIZE AND KIND OF PIPE/CABLE no pipe

NUMBER OF EXCAVATIONS 1

SIZE OF EXCAVATIONS 28 Feet at it's widest

(Length, width, and depth)

LOCATION OF EXCAVATIONS ALL EXCAVATIONS ARE TO BE PROTECTED AT ALL TIMES AND THEN BACKFILLED WHEN UNATTENDED AND/OR OVERNIGHT

Specific written descriptions of excavations - if shown on attached drawing, drawing shall be specific with depth and distance from centerline, curb, or other distinguishable location. Traffic control plans cannot be approved without specific excavation descriptions.

See Plan Sheets

PER APPROVED PLANS ON FILE AT ACHD

THIS PERMIT COVERS THE RIGHT OF WAY IN ANOKA COUNTY ONLY

ACTD reserves the right to make changes to these special conditions.



Anoka County

MINNESOTA

Respectful. Innovative. Fiscally Responsible

ANOKA COUNTY TRANSPORTATION DIVISION

1440 BUNKER LAKE BLVD NW

ANDOVER, MN 55304

PERMIT PHONE: 763-324-3176

highwaypermits@anokacountymn.gov

GENERAL INFORMATION

One permit must be approved for each county road on which work will be performed prior to any work within the right of way by any utility/contractor. Emergency conditions which threaten the safety of the public and require immediate repair are exceptions to this rule. Under those circumstances, the utility/contractor is permitted to begin and/or complete the necessary repairs. The Anoka County Transportation Division (ACTD) shall be notified of emergency repairs as soon as feasible and a written permit is to be completed within two business days of occurrence.

A license-permit bond is generally required of the contractor as part of the registration process, the amount of which will be determined by the nature of the utility work.

A sketch or drawing shall accompany each permit application which will show the location of the proposed work/utility with reference to the county highway center line and right of way line. A complete set of plans is required for all sewer/water projects.

It shall be the responsibility of the applicant to determine which of the special conditions apply to each permit.

ACTD reserves the right to revoke any utility permit and halt work, if, upon inspection of any job site, the special conditions are not met, and/or a hazard exists for the applicant or public safety is threatened. **The failure to comply with the terms and conditions of any applicable Federal, State, Regional, and local laws, rules and regulations, including any provision of Anoka County's Right-of-Way Ordinance shall be cause for immediate revocation of a permit.**

The applicant shall notify ACTD immediately upon completion of project so that the ACTD can inspect the site to determine if restoration has been satisfactorily completed.

The undersigned hereby accepts the terms and conditions of this permit and the regulations of Anoka County, and agrees to fully comply therewith to the satisfaction of the ACTD. The county of Anoka, its officials, employees, and agents, shall be held harmless, by the applicant/permittee, from any demands, claims, lawsuits, or damages relating to the work described in this permit.

APPLICANT'S SIGNATURE	<small>Signed by:</small> <i>Nicholas J Arnt</i>	DATE	7/24/2024
-----------------------	---	------	-----------

1694B7D155494EF...

AUTHORIZATION OF PERMIT

In consideration of the applicant's agreement to comply in all respects with the regulations of the ACTD covering such operations, permission is hereby granted for the work to be done as described in the above application. Said work to be done in accordance with the general conditions listed above and the special conditions required as hereby stated. It is expressly understood that this permit is conditioned upon replacement or restoration of the county highway and its right of way to their original or to a satisfactory condition. It is further understood that this permit is issued subject to the approval of local city or township authorities having joint supervision over said street or highway.

APPROVED BY:	<small>DocuSigned by:</small> <i>Susan Burgmeier</i>	DATE	7/25/2024
TITLE: Traffic Technician	<small>05E91FE156D44EE...</small>		

NOT VALID UNLESS SIGNED BY ANOKA COUNTY

THIS PERMIT COVERS THE RIGHT OF WAY IN ANOKA COUNTY ONLY
ACTD reserves the right to make changes to these special conditions.



ANOKA COUNTY TRANSPORTATION DIVISION

1440 BUNKER LAKE BLVD NW

ANDOVER, MN 55304

PERMIT PHONE: 763-324-3176

highwaypermits@anokacountymn.gov

SPECIAL CONDITIONS

TRAFFIC CONTROL

- 1) Detours
 - a) Detailed detour layouts shall be submitted to the traffic engineer for approval.
 - b) No detours shall be permitted without prior approval of the Anoka county traffic engineer.
 - c) A ten day notice must be given prior to the installation of any detour.
 - d) It shall be the responsibility of the applicant to notify Anoka county central communications, local government bodies, and any affected bus companies ten days prior to any road closures/detours.
 - e) Immediately upon completion of work and/or detours, all posts, barricades, and signs shall be removed from the right of way.
- 2) Traffic control devices
 - a) All traffic control devices, barricades, flashers, etc., shall be furnished by the applicant and shall be in accordance with the most recent edition of the Minnesota manual on uniform traffic control devices and temporary traffic control zone layouts – field manual of the same manual.

CONSTRUCTION REQUIREMENTS

- 1) Open cutting of bituminous or concrete surfaced roads will be allowed only at the discretion of the county engineer.
- 2) Neither supplies nor excavation materials shall be placed on the bituminous or concrete surface at any time.
- 3) No trenches will be allowed to remain open overnight.
- 4) Materials removed from the trench shall be used as backfill insofar as they are suitable. All backfill material shall conform to MNDOT specifications for compaction. The use of heavy equipment on top of trench, slapping with backhoe bucket and/or back casting to achieve compaction is prohibited. Any additional material required to back fill to the original grade shall be furnished by the applicant at no expense to the ACTD. All the base and surface courses damaged during construction operations shall be restored to a condition equal to or better than before operations began. The applicant shall be responsible for and restore any settlement.
- 5) All culverts, ditches, shoulders, and backslopes shall be restored to their original condition unless otherwise directed by the ACTD. Shoulders which have been previously constructed or reconstructed with special materials shall be replaced in kind. Restoration of signs, guardrails, guard posts, etc., are the sole responsibility of the applicant and shall be restored to their original condition.
- 6) All roadway maintenance required within the limits of the utility project that is related to the applicant's activities shall be the sole responsibility of the applicant for one year after completion of the project. Upon completion of the restoration work, the applicant shall request a final inspection by the ACTD. The ACTD's approved completion date shall be the starting date of the applicant's one-year responsibility.

HORIZONTAL BORING AND JACKING

- 1) All hard surface roadways shall be jacked or bored.
- 2) All crossings of Anoka County maintained roadbeds, shall be made by boring inside a casing or carrier pipe, or by jacking unless otherwise directed by the Anoka County Engineer. The auger shall lead the casing or carrier pipe by at least six inches whenever possible and never lead the carrier pipe by more than one inch.
- 3) The use of pneumatic devices to facilitate the roadbed crossings will be allowed in most cases with prior approval. In the event approval is not granted and applicant uses a pneumatic device to cross a roadbed and encounters an obstruction and/or unstable subbase material which makes forward or reverse motion of pneumatic device impossible, said pneumatic device then becomes part of the roadway subbase and permission to excavate to retrieve device will not be granted.
- 4) If a pneumatic device is used for the work permitted herein, the installation must be kept to a minimum of four feet below the surface of the roadway if the pneumatic device is less than two inches in diameter, and a minimum of five feet below the surface of the roadway if the pneumatic device is two inches in diameter or larger.

BITUMINOUS RESTORATION

- 1) The locations and dimensions of all openings to be made in the bituminous surface shall be approved by the ACTD prior to any cutting or any surface opening operations.
- 2) All openings in bituminous surfaces shall be cut in a straight line with the sides smooth and vertical. No ragged edges will be permitted. Cutting shall be done with a concrete saw.
- 3) All necessary dust control operations shall be carried out by the applicant at no expense to Anoka County.
- 4) The minimum requirement for subgrade replacement shall be the upper twelve inches of material and shall meet MNDOT specifications for class five placed in six inch layers compacted to one hundred percent of optimum density.
- 5) All manhole casings, gate valves, and other utility structures shall be set one quarter inch below the top of the finished surface.
- 6) Bituminous tack coat materials and application thereof shall conform to MNDOT specification 2357.
- 7) All bituminous surfacing shall be replaced as soon as practicable after the base construction. All bituminous surfacing shall be machine laid. Any exceptions must be approved by the ACTD. Bituminous surfacing shall be replaced to original pavement depth or to a minimum of six inches of bituminous mixture (2360), whichever is greater. Bituminous mixtures must be placed in lifts not exceeding three inches in thickness for base and binder courses and not exceeding two inches for the wear course.
- 8) All surface restoration regardless of size shall conform to existing grades.
- 9) Any unnecessary or negligent damage to bituminous surface in conjunction with the installation and/or repair of a utility shall be cut out and replaced in kind as directed by the ACTD.

THIS PERMIT COVERS THE RIGHT OF WAY IN ANOKA COUNTY ONLY
ACTD reserves the right to make changes to these special conditions.



ANOKA COUNTY TRANSPORTATION DIVISION

1440 BUNKER LAKE BLVD NW

ANDOVER, MN 55304

PERMIT PHONE: 763-324-3176

highwaypermits@anokacountymn.gov

CONCRETE RESTORATION

- 1) Curb and gutter, sidewalks, and driveways shall be restored in accordance with MNDOT specifications 2531 and 2521.

UTILITY LINES

- 1) There shall be only a single pole line on the county right of way on either side of the center line thereof.
- 2) Exact locations of longitudinal installations on county highways shall be located as directed by the ACTD.

SECTION CORNER MONUMENTS

- 1) Utility locations shall not interfere with the location of any section, quarter, witness, or right of way monuments. For assistance in locations, contact the Anoka County Surveyor's Office.
- 2) The applicant shall be responsible for replacement of any existing property irons disturbed during construction.
- 3) The applicant shall notify the Anoka County Surveyor's Office three working days in advance of any anticipated disturbance of any section, quarter, witness, or right of way monuments.
- 4) Any monument disturbed during the course of construction, shall be reset by the Anoka County Surveyor's Office at the expense of the applicant.

ATTACHING TO BRIDGES/STRUCTURES

- 1) No utility is permitted to be hung from, or otherwise attached to, any bridge or structure without having detailed plans approved by the Anoka County Engineer. These plans are to show approaches to the structure, method of installation, type, and dimension of housing for the utility.

ADDITIONAL PROVISIONS

- 1) All subcontractors, installers, and crew shall possess a physical or electronic copy of all documents in relation to the approved permit prior to the commencement of work and be kept on site. This includes, but it not limited to the following:
 - a) Approved permit
 - b) Any/all traffic control plans and/or layouts
- 2) Shall notify Anoka County Permits at 763-324-3176 or highwaypermits@anokacountymn.gov
 - a) At least 36 hours prior to the commencement of work
 - b) With time frame of proposed of work
 - c) Anticipated traffic control
 - d) When work is complete - including restorations - to request a final inspection
- 3) No work during inclement weather or when plows are out in any capacity
- 4) All traffic control shall be in accordance with the most current version of the MnDOT Temporary Traffic Control Field Manual
- 5) For staking of right-of way or proposed infrastructure, contact Chris Osterhus at 763-324-3189 a minimum of 48 hours prior to the commencement of work.

INITIAL Initial
NJL



No additional comments.

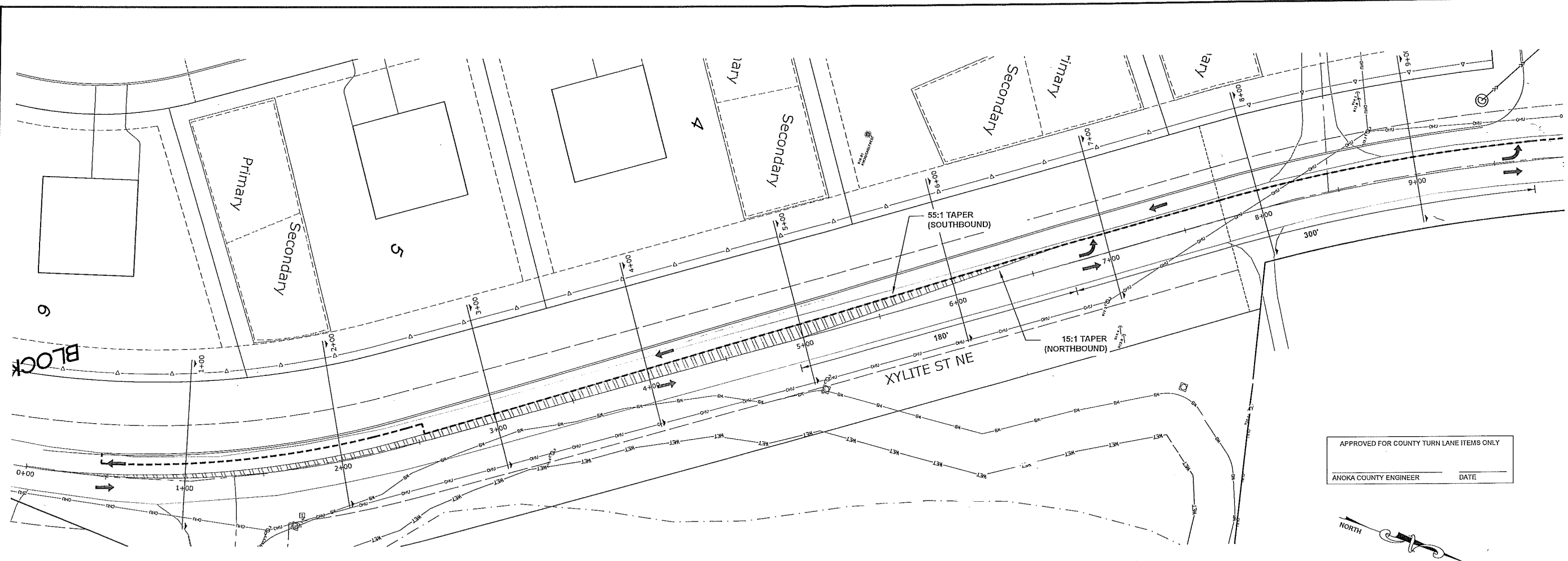

— = EDGE OF EXISTING BITUMINOUS
 - - - = SAWCUT LINE

APPROVED FOR COUNTY TURN LANE ITEMS ONLY
 ANOKA COUNTY ENGINEER _____ DATE _____

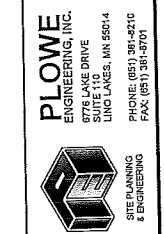
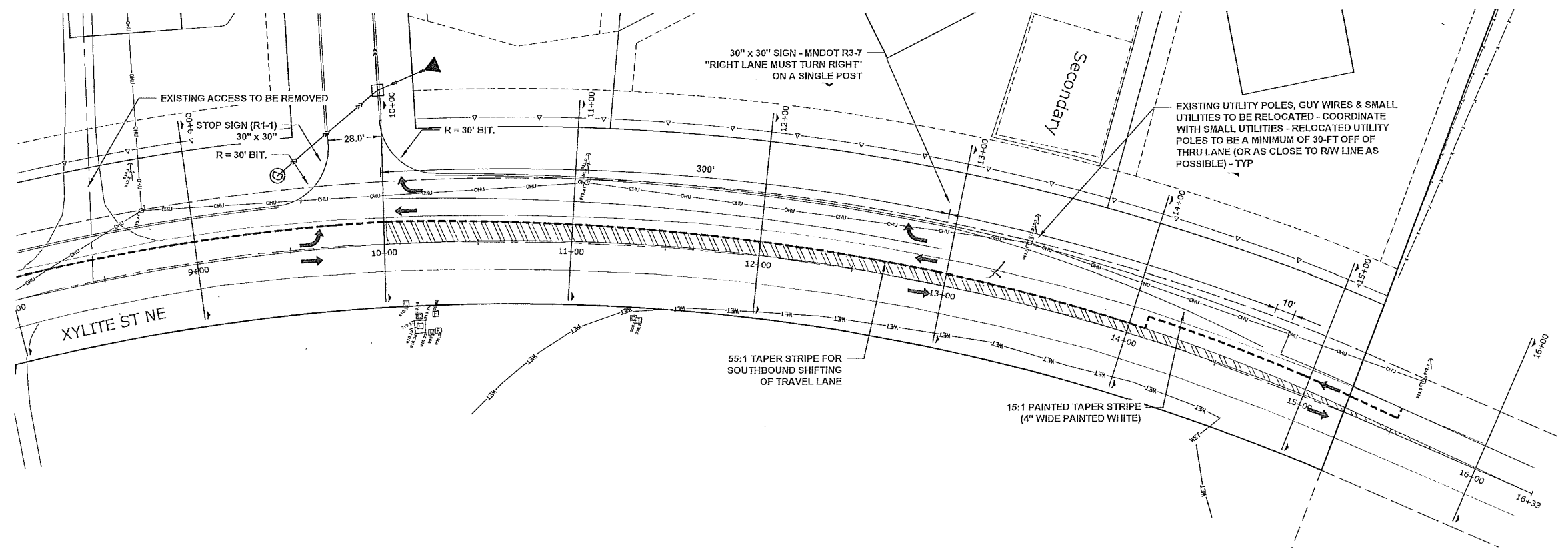
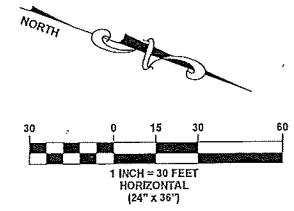

DRAWN BY: AG
 JOB NO.: 23-2122
 CHECK BY: MCA
 DATE: 03/20/24

NO.	DATE	DESCRIPTION
1	04-10-24	RFC & CSWD COMMENT 5
2	04-17-24	ADDITIONAL TURN LANE DETAIL
3		
4		
5		
6		
7		
8		
9		

I hereby certify that this plan was prepared by me or under my direct supervision and that I am a duly licensed professional engineer under the laws of the State of Minnesota.
PRELIMINARY
 ADAM GINKEL
 License No. 43963
 Date: 04/17/2024

SWEDISH CHAPEL ESTATES
 HAM LAKE, MN
LEFT & RIGHT TURN LANE PLAN
 PREPARED FOR: MN DEVELOPMENTS, LLC

SHEET
C4.1

GENERAL NOTES

1. THE INFORMATION SHOWN ON THESE DRAWINGS CONCERNING TYPE AND LOCATION OF EXISTING UTILITIES IS NOT GUARANTEED TO BE ACCURATE OR ALL INCLUSIVE. THE CONTRACTOR IS RESPONSIBLE FOR MAKING HIS OWN DETERMINATION AS TO TYPE AND LOCATION OF UTILITIES AS NECESSARY TO AVOID DAMAGE TO THESE UTILITIES.
2. CALL "811" FOR EXISTING UTILITIES LOCATIONS PRIOR TO ANY EXCAVATIONS.
3. THE CONTRACTOR SHALL FIELD VERIFY SIZE, ELEVATION, AND LOCATION OF EXISTING UTILITIES AND NOTIFY ENGINEER OF ANY DISCREPANCIES PRIOR TO THE START OF INSTALLATIONS.
4. INSTALLATIONS SHALL CONFORM TO THE CITY STANDARD SPECIFICATIONS AND DETAIL PLATES.
5. STORAGE OF MATERIALS OR EQUIPMENT SHALL NOT BE ALLOWED ON PUBLIC STREETS OR WITHIN PUBLIC RIGHT-OF-WAY.
6. NOTIFY CITY AND COON CREEK WATERSHED DISTRICT (CCWD) A MINIMUM OF 48 HOURS PRIOR TO THE COMMENCEMENT OF CONSTRUCTION.
7. ALL ELECTRIC, TELEPHONE, AND GAS EXTENSIONS INCLUDING SERVICE LINES SHALL BE CONSTRUCTED TO THE APPROPRIATE UTILITY COMPANY SPECIFICATIONS. ALL UTILITY DISCONNECTIONS SHALL BE COORDINATED WITH THE APPROPRIATE UTILITY COMPANY.

APPROVED FOR COUNTY TURN LANE SYSTEMS ONLY

ANOKA COUNTY ENGINEER _____ DATE _____

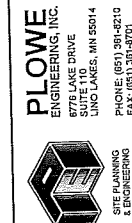

PLOWE ENGINEERING, INC.
 8776 LAKE DRIVE
 SUITE 110
 LINDA LAKE, MN 55914
 PHONE: (855) 381-8910
 FAX: (855) 381-8911

DRAWN BY: _____
 ASG
 JOB NO.: 23-2122
 CHECK BY: MGA
 DATE: 03/20/24

NO.	DATE	DESCRIPTION
1	04.15.24	RFC & CCWD COMMENTS
2	04.17.24	ADDITIONAL TURN LANE DETAIL
3		
4		
5		
6		
7		
8		

I hereby certify that this plan was prepared by me or under my direct supervision and that I am a duly licensed Professional Engineer under the laws of the State of Minnesota.

PRELIMINARY
 ADAM GINKEL
 Date: 04.17.2024 License No. 48963

**XYLITE ST NE
 SOUTHBOUND RIGHT TURN LANE**

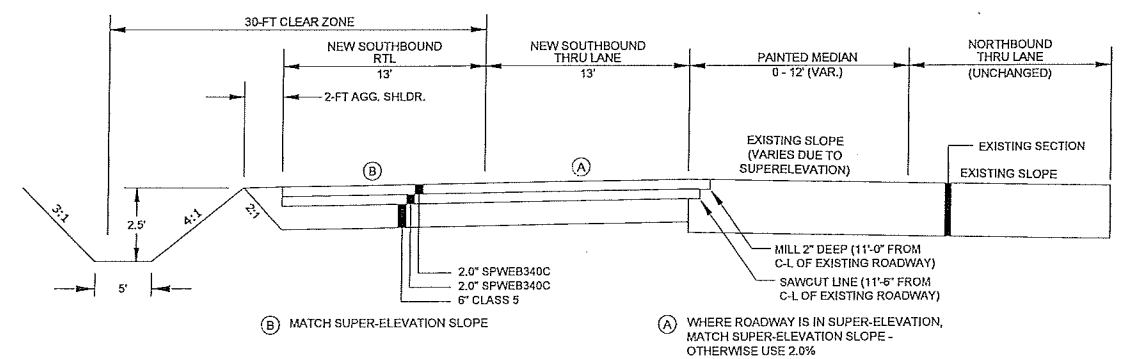

- NOTES**
1. ALL INSTALLATIONS SHALL BE IN ACCORDANCE WITH MNDOT SPECIFICATIONS (LATEST EDITION)
 2. ALL DISTURBED SOIL WITHIN COUNTY RIGHT-OF-WAY MUST BE SEEDED (MNDOT 25-141) & MULCHED (TYPE 1, DISC ANCHORED)
 3. USE ALL STRAW FIBER BLANKET FOR DITCH SLOPES OF 3:1 OR GREATER
 4. PAVEMENT MARKINGS SHALL BE EPOXY
 5. CONTRACTOR TO CONTACT ANOKA COUNTY PERMITS SECTION AT (763) 324-3176 TO OBTAIN THE RIGHT-OF-WAY PERMIT.

**XYLITE ST NE
 NORTHBOUND LEFT TURN LANE**

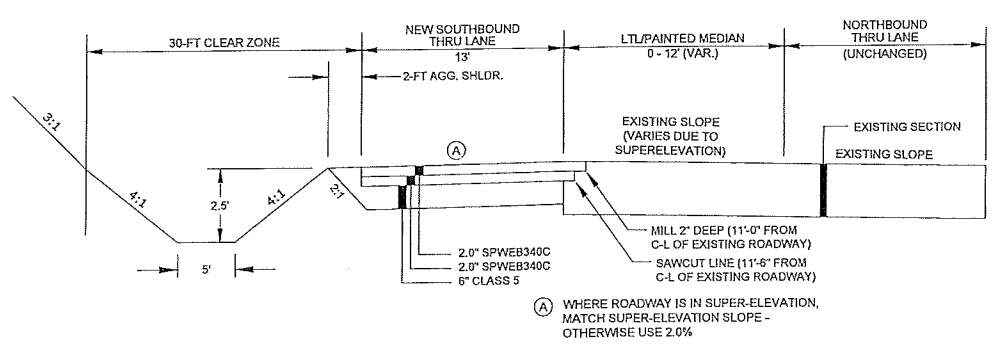

- NOTES**
1. ALL INSTALLATIONS SHALL BE IN ACCORDANCE WITH MNDOT SPECIFICATIONS (LATEST EDITION)
 2. ALL DISTURBED SOIL WITHIN COUNTY RIGHT-OF-WAY MUST BE SEEDED (MNDOT 25-141) & MULCHED (TYPE 1, DISC ANCHORED)
 3. USE ALL STRAW FIBER BLANKET FOR DITCH SLOPES OF 3:1 OR GREATER
 4. PAVEMENT MARKINGS SHALL BE EPOXY
 5. CONTRACTOR TO CONTACT ANOKA COUNTY PERMITS SECTION AT (763) 324-3176 TO OBTAIN THE RIGHT-OF-WAY PERMIT.

SWEDISH CHAPEL ESTATES
 HAM LAKE, MN
LEFT & RIGHT TURN LANE PLAN
 PREPARED FOR: MN DEVELOPMENTS, LLC

SHEET
C4.2

APPROVED FOR COUNTY TURN LANE ITEMS ONLY
 ANOKA COUNTY ENGINEER _____ DATE _____

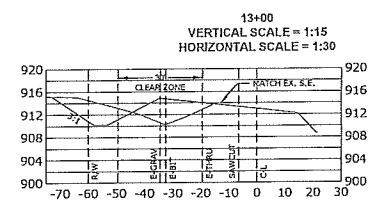
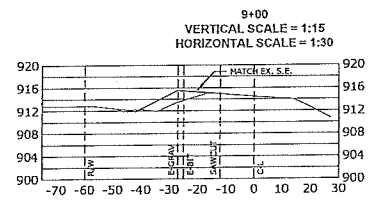
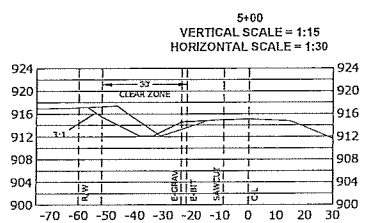
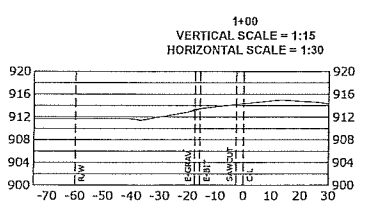
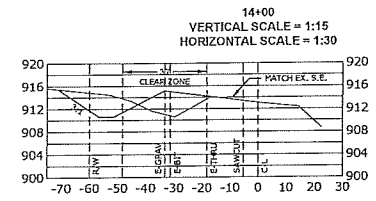
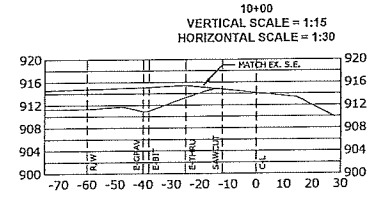
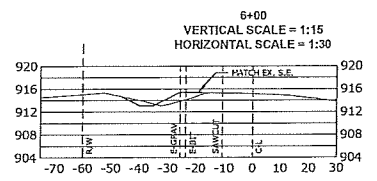
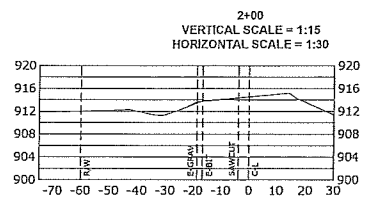
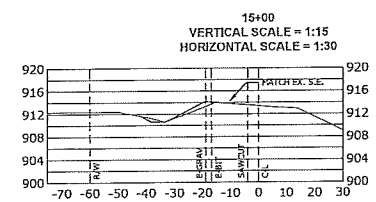
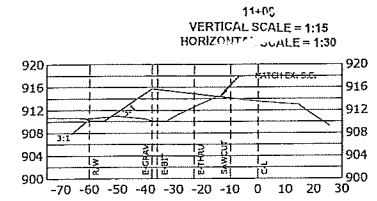
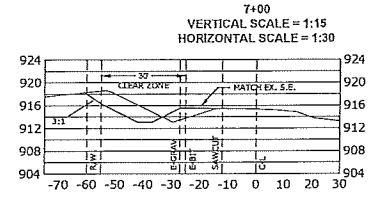
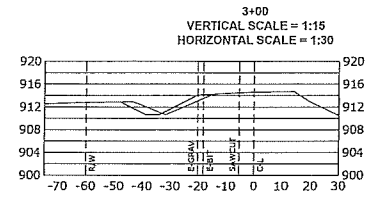
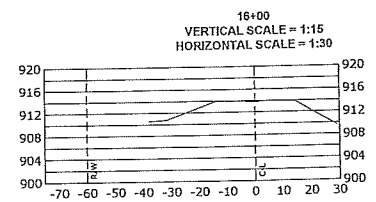
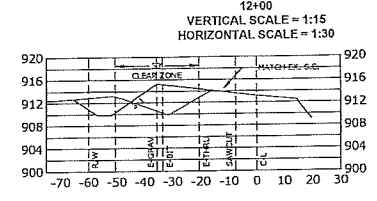
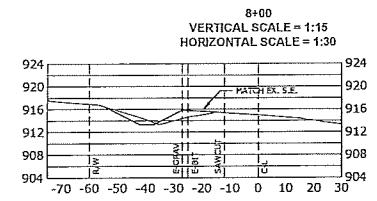
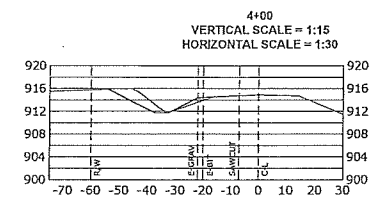

ALL GREEN AREA SLOPES ARE 4:1 UNLESS OTHERWISE NOTED
 S.E. = SUPER-ELEVATION

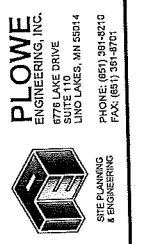

PLOWE ENGINEERING, INC.
 6772 LAKE DRIVE
 SUITE 10
 LIND LAKES, MN 55114
 PHONE: (951) 301-8210
 FAX: (951) 361-8711

DRAWN BY:	AG
JOB NO.:	23-2122
CHECK BY:	MGA
DATE:	03/20/24

I hereby certify that this plan was prepared by me or under my direct supervision and that I am a duly licensed Professional Engineer under the laws of the State of Minnesota.
PRELIMINARY
 ADAM GINKEL
 Date: 04.17.2024 License No. 49983

SWEDISH CHAPEL ESTATES
 HAM LAKE, MN
LEFT & RIGHT TURN LANE PLAN
 PREPARED FOR: MN DEVELOPMENTS, LLC

SHEET
C4.3

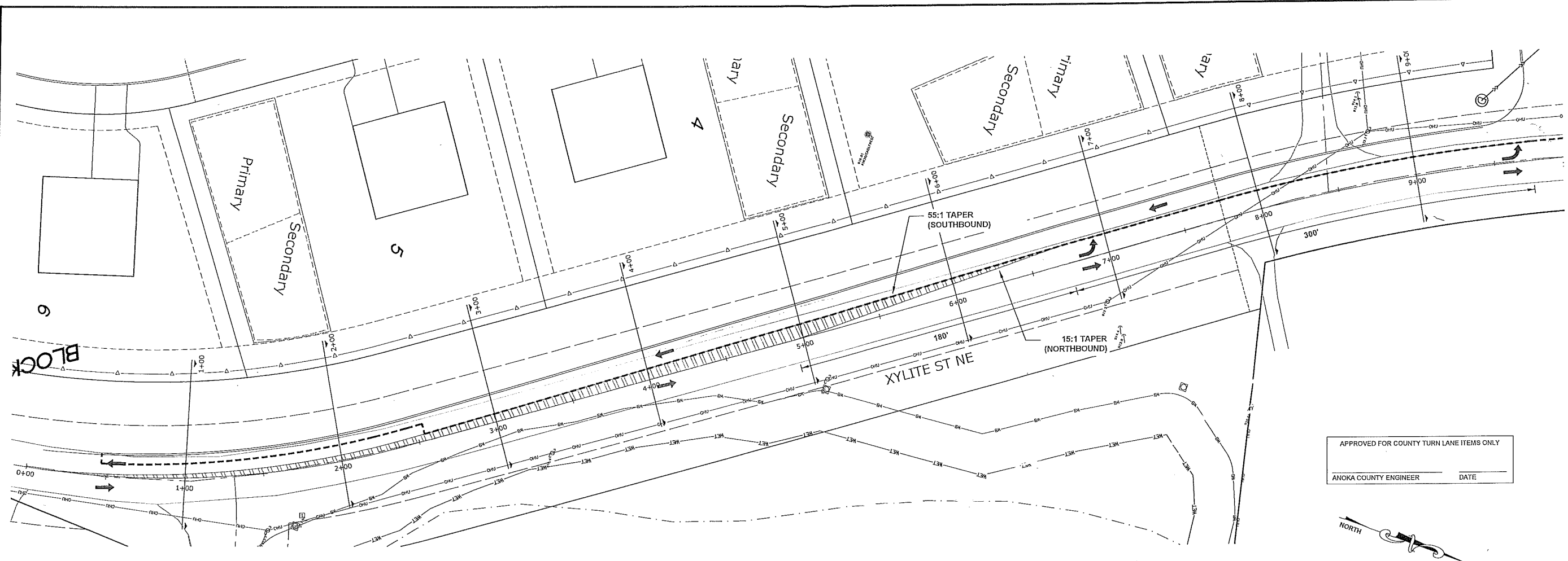

— = EDGE OF EXISTING BITUMINOUS
 - - - = SAWCUT LINE

APPROVED FOR COUNTY TURN LANE ITEMS ONLY
 ANOKA COUNTY ENGINEER _____ DATE _____

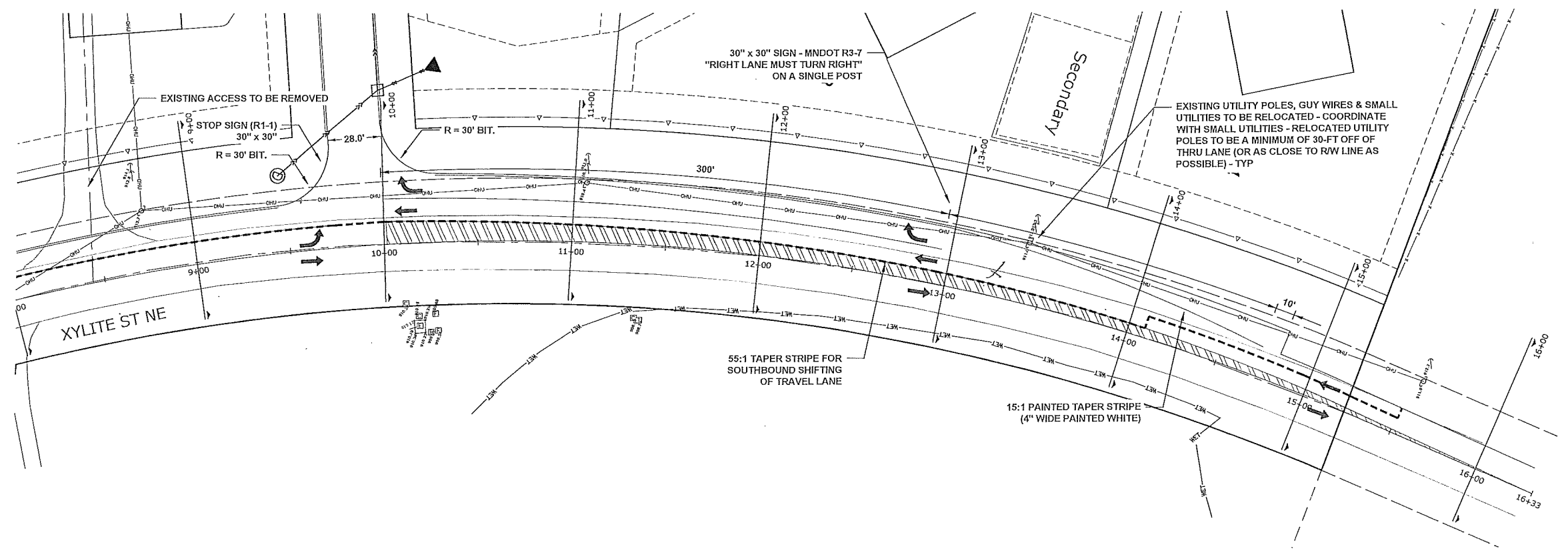
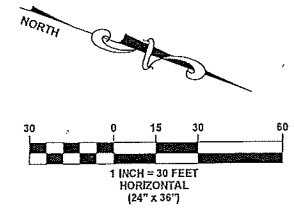

PLOWE ENGINEERING, INC.
 6776 LAKE DRIVE
 SUITE 110
 LINO LAKE, MN 55014
 PHONE: (951) 381-4210
 FAX: (951) 381-8701

DRAWN BY: AG	CHECKED BY: MCA	DATE: 03/20/24
JOB NO: 23-2122		
DATE: 03/20/24		
NO.	DATE	DESCRIPTION
1	04-10-24	RFC & CSWD COMMENT 5
2	04-17-24	ADDITIONAL TURN LANE DETAIL
3		
4		
5		
6		
7		
8		
9		

I hereby certify that this plan was prepared by me or under my direct supervision and that I am a duly licensed professional engineer under the laws of the State of Minnesota.
PRELIMINARY
 ADAM GINKEL
 License No. 43963
 Date: 04/17/2024

SWEDISH CHAPEL ESTATES
 HAM LAKE, MN
LEFT & RIGHT TURN LANE PLAN
 PREPARED FOR: MN DEVELOPMENTS, LLC

SHEET
C4.1

GENERAL NOTES

1. THE INFORMATION SHOWN ON THESE DRAWINGS CONCERNING TYPE AND LOCATION OF EXISTING UTILITIES IS NOT GUARANTEED TO BE ACCURATE OR ALL INCLUSIVE. THE CONTRACTOR IS RESPONSIBLE FOR MAKING HIS OWN DETERMINATION AS TO TYPE AND LOCATION OF UTILITIES AS NECESSARY TO AVOID DAMAGE TO THESE UTILITIES.
2. CALL "811" FOR EXISTING UTILITIES LOCATIONS PRIOR TO ANY EXCAVATIONS.
3. THE CONTRACTOR SHALL FIELD VERIFY SIZE, ELEVATION, AND LOCATION OF EXISTING UTILITIES AND NOTIFY ENGINEER OF ANY DISCREPANCIES PRIOR TO THE START OF INSTALLATIONS.
4. INSTALLATIONS SHALL CONFORM TO THE CITY STANDARD SPECIFICATIONS AND DETAIL PLATES.
5. STORAGE OF MATERIALS OR EQUIPMENT SHALL NOT BE ALLOWED ON PUBLIC STREETS OR WITHIN PUBLIC RIGHT-OF-WAY.
6. NOTIFY CITY AND COON CREEK WATERSHED DISTRICT (CCWD) A MINIMUM OF 48 HOURS PRIOR TO THE COMMENCEMENT OF CONSTRUCTION.
7. ALL ELECTRIC, TELEPHONE, AND GAS EXTENSIONS INCLUDING SERVICE LINES SHALL BE CONSTRUCTED TO THE APPROPRIATE UTILITY COMPANY SPECIFICATIONS. ALL UTILITY DISCONNECTIONS SHALL BE COORDINATED WITH THE APPROPRIATE UTILITY COMPANY.

APPROVED FOR COUNTY TURN LANE PERMIT SYSTEM ONLY

ANOKA COUNTY ENGINEER DATE

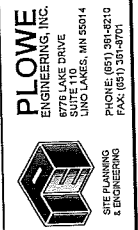

DRAWN BY: [Blank]
 AG: [Blank]
 JOB NO.: 23-2122
 CHECK BY: MGA
 DATE: 03/20/24

NO.	DATE	DESCRIPTION
1	04.15.24	RFC & CCWD COMMENTS
2	04.17.24	ADDITIONAL TURN LANE DETAIL
3		
4		
5		
6		
7		
8		

I hereby certify that this plan was prepared by me or under my direct supervision and that I am a duly licensed professional engineer under the laws of the State of Minnesota.

PRELIMINARY
 ADAM GINKEL
 Date: 04.17.2024 License No. 48963

XYLITE ST NE
 SOUTHBOUND RIGHT TURN LANE

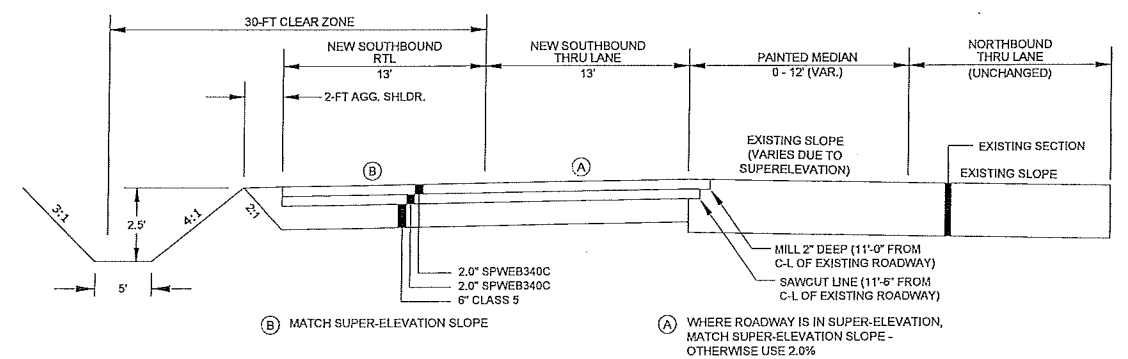

- NOTES
1. ALL INSTALLATIONS SHALL BE IN ACCORDANCE WITH MNDOT SPECIFICATIONS (LATEST EDITION)
 2. ALL DISTURBED SOIL WITHIN COUNTY RIGHT-OF-WAY MUST BE SEEDED (MNDOT 25-141) & MULCHED (TYPE 1, DISC ANCHORED)
 3. USE ALL STRAW FIBER BLANKET FOR DITCH SLOPES OF 3:1 OR GREATER
 4. PAVEMENT MARKINGS SHALL BE EPOXY
 5. CONTRACTOR TO CONTACT ANOKA COUNTY PERMITS SECTION AT (763) 324-3176 TO OBTAIN THE RIGHT-OF-WAY PERMIT.

XYLITE ST NE
 NORTHBOUND LEFT TURN LANE

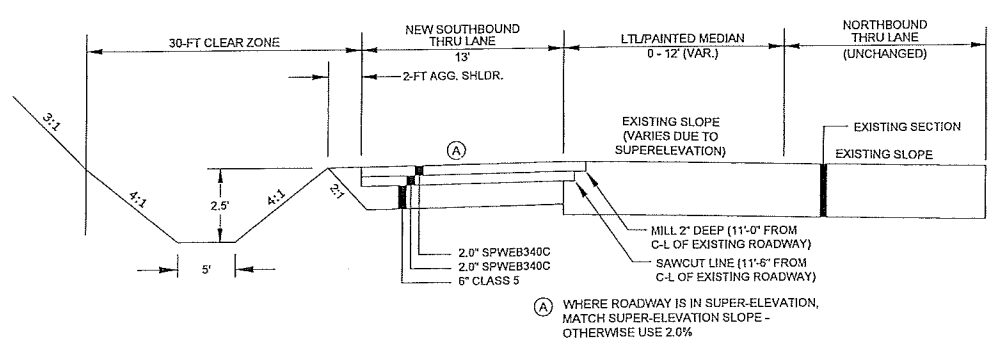

- NOTES
1. ALL INSTALLATIONS SHALL BE IN ACCORDANCE WITH MNDOT SPECIFICATIONS (LATEST EDITION)
 2. ALL DISTURBED SOIL WITHIN COUNTY RIGHT-OF-WAY MUST BE SEEDED (MNDOT 25-141) & MULCHED (TYPE 1, DISC ANCHORED)
 3. USE ALL STRAW FIBER BLANKET FOR DITCH SLOPES OF 3:1 OR GREATER
 4. PAVEMENT MARKINGS SHALL BE EPOXY
 5. CONTRACTOR TO CONTACT ANOKA COUNTY PERMITS SECTION AT (763) 324-3176 TO OBTAIN THE RIGHT-OF-WAY PERMIT.

SWEDISH CHAPEL ESTATES
 HAM LAKE, MN
LEFT & RIGHT TURN LANE PLAN
 PREPARED FOR: MN DEVELOPMENTS, LLC

SHEET
C4.2

APPROVED FOR COUNTY TURN LANE ITEMS ONLY
 ANOKA COUNTY ENGINEER _____ DATE _____

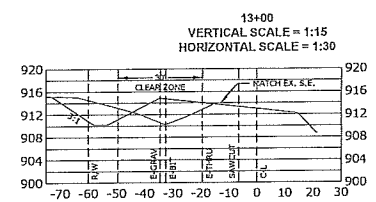
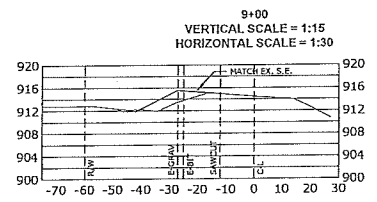
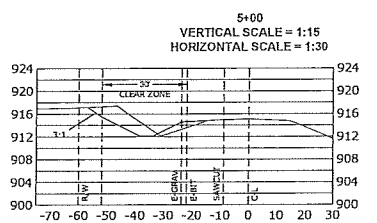
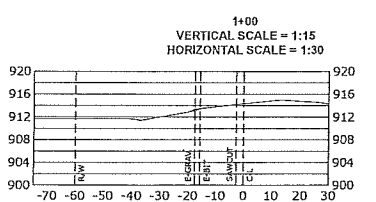
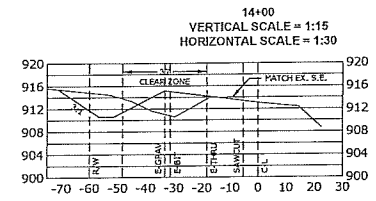
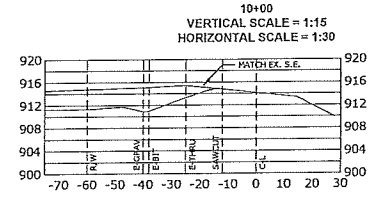
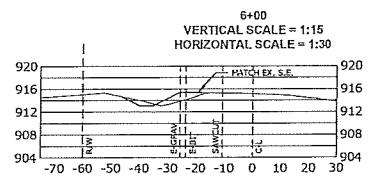
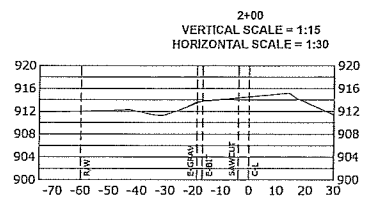
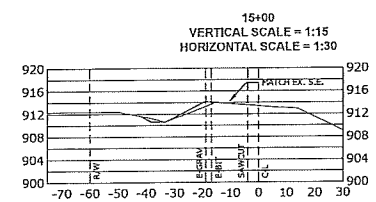
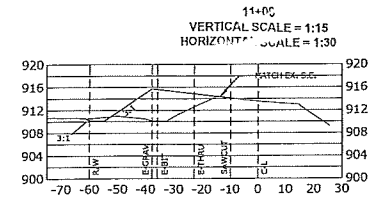
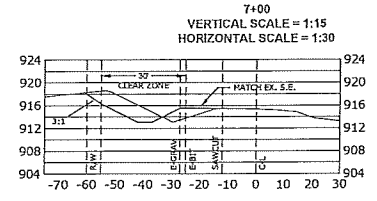
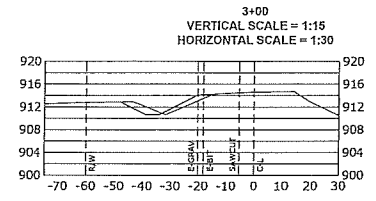
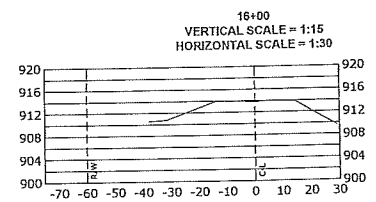
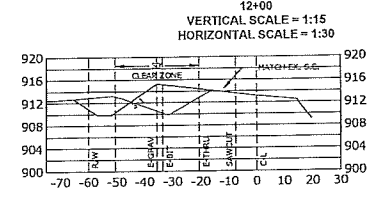
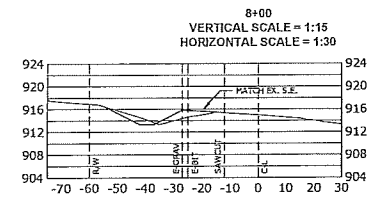
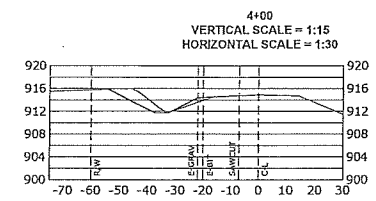

ALL GREEN AREA SLOPES ARE 4:1 UNLESS OTHERWISE NOTED
 S.E. = SUPER-ELEVATION

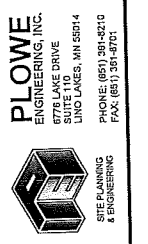

PLOWE ENGINEERING, INC.
 6772 LAKE DRIVE
 SUITE 10
 LIND LAKES, MN 55114
 PHONE: (951) 301-8210
 FAX: (951) 361-8711

1	04-17-24	SHEET ADDED TO SET
2		
3		
4		
5		
6		
7		
8		

I hereby certify that this plan was prepared by me or under my direct supervision and that I am a duly licensed Professional Engineer under the laws of the State of Minnesota.
PRELIMINARY
 ADAM GINKEL
 Date: 04.17.2024 License No. 49983

SWEDISH CHAPEL ESTATES
 HAM LAKE, MN
LEFT & RIGHT TURN LANE PLAN
 PREPARED FOR: MN DEVELOPMENTS, LLC

SHEET
C4.3

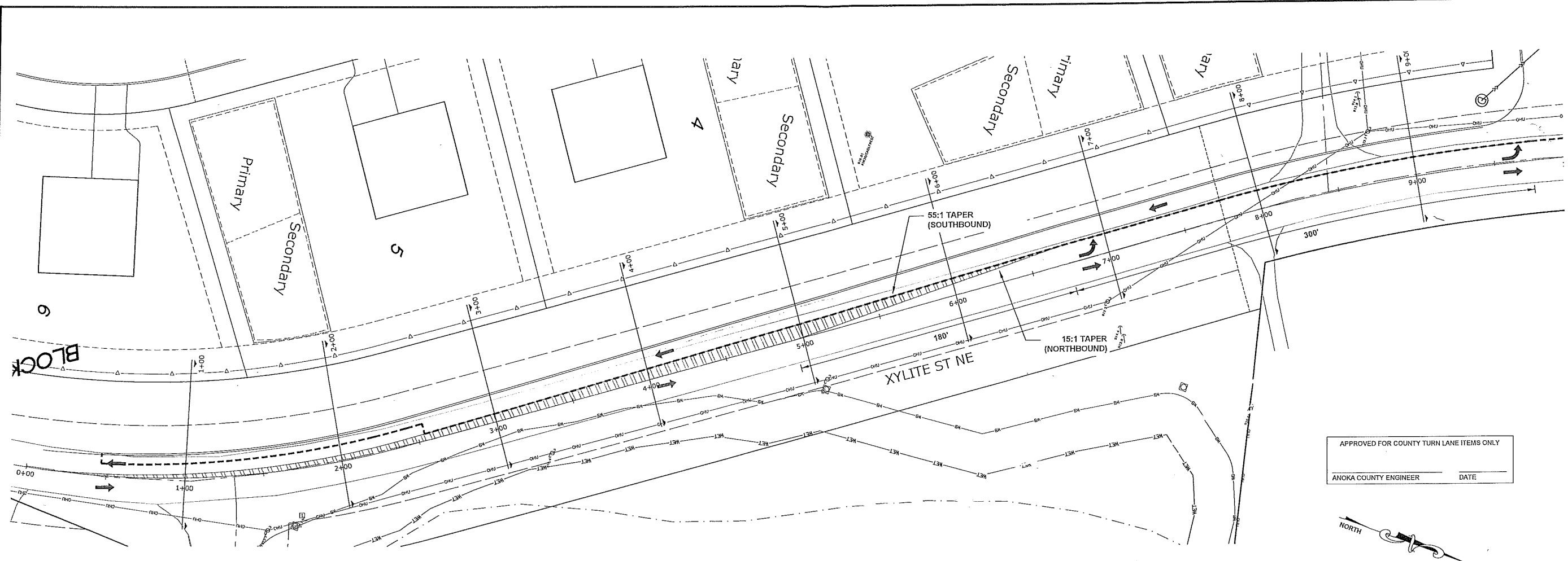

— = EDGE OF EXISTING BITUMINOUS
 - - - = SAWCUT LINE

APPROVED FOR COUNTY TURN LANE ITEMS ONLY
 ANOKA COUNTY ENGINEER _____ DATE _____

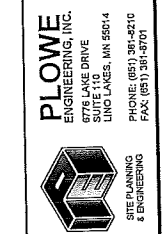
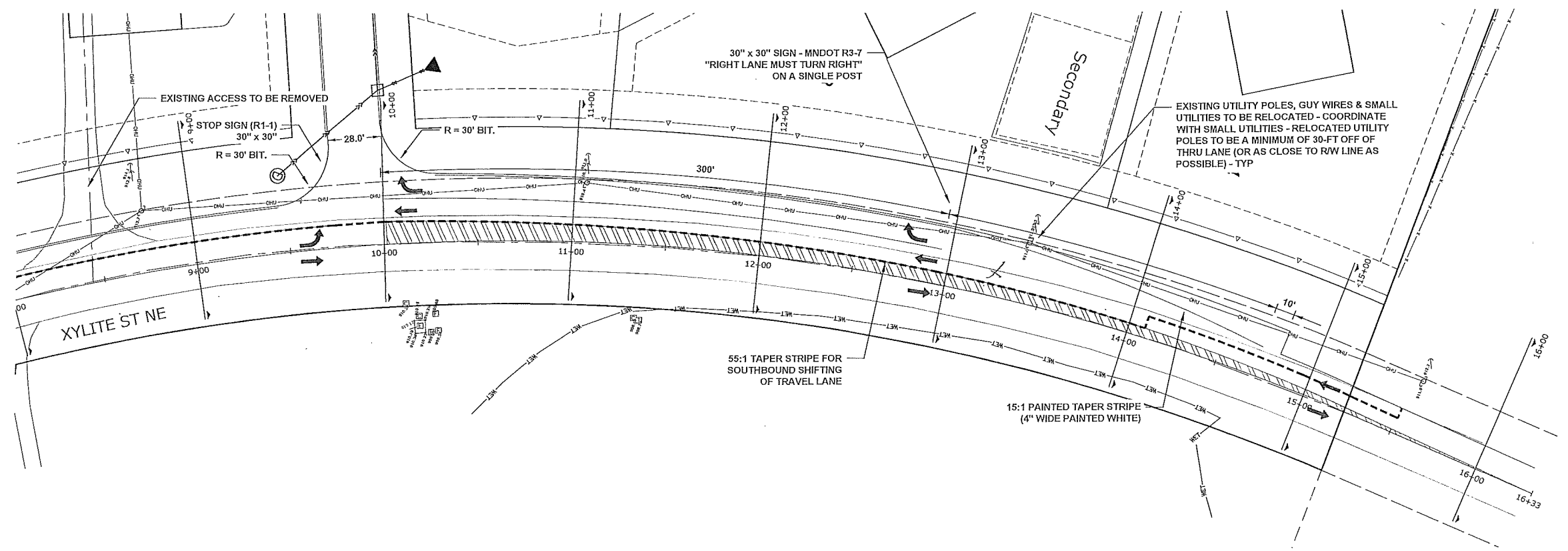
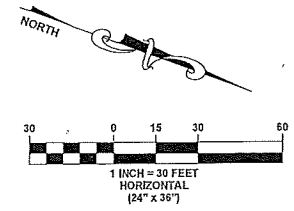

DRAWN BY: AG
 JOB NO.: 23-2122
 CHECK BY: MCA
 DATE: 03/20/24

NO.	DATE	DESCRIPTION
1	04-10-24	RFC & CSWD COMMENT 5
2	04-17-24	ADDITIONAL TURN LANE DETAIL
3		
4		
5		
6		
7		
8		
9		

I hereby certify that this plan was prepared by me or under my direct supervision and that I am a duly licensed professional engineer under the laws of the State of Minnesota.
PRELIMINARY
 ADAM GINKEL
 License No. 49963
 Date: 04.17.2024

SWEDISH CHAPEL ESTATES
 HAM LAKE, MN
LEFT & RIGHT TURN LANE PLAN
 PREPARED FOR: MN DEVELOPMENTS, LLC

SHEET
C4.1

GENERAL NOTES

1. THE INFORMATION SHOWN ON THESE DRAWINGS CONCERNING TYPE AND LOCATION OF EXISTING UTILITIES IS NOT GUARANTEED TO BE ACCURATE OR ALL INCLUSIVE. THE CONTRACTOR IS RESPONSIBLE FOR MAKING HIS OWN DETERMINATION AS TO TYPE AND LOCATION OF UTILITIES AS NECESSARY TO AVOID DAMAGE TO THESE UTILITIES.
2. CALL "811" FOR EXISTING UTILITIES LOCATIONS PRIOR TO ANY EXCAVATIONS.
3. THE CONTRACTOR SHALL FIELD VERIFY SIZE, ELEVATION, AND LOCATION OF EXISTING UTILITIES AND NOTIFY ENGINEER OF ANY DISCREPANCIES PRIOR TO THE START OF INSTALLATIONS.
4. INSTALLATIONS SHALL CONFORM TO THE CITY STANDARD SPECIFICATIONS AND DETAIL PLATES.
5. STORAGE OF MATERIALS OR EQUIPMENT SHALL NOT BE ALLOWED ON PUBLIC STREETS OR WITHIN PUBLIC RIGHT-OF-WAY.
6. NOTIFY CITY AND COON CREEK WATERSHED DISTRICT (CCWD) A MINIMUM OF 48 HOURS PRIOR TO THE COMMENCEMENT OF CONSTRUCTION.
7. ALL ELECTRIC, TELEPHONE, AND GAS EXTENSIONS INCLUDING SERVICE LINES SHALL BE CONSTRUCTED TO THE APPROPRIATE UTILITY COMPANY SPECIFICATIONS. ALL UTILITY DISCONNECTIONS SHALL BE COORDINATED WITH THE APPROPRIATE UTILITY COMPANY.

APPROVED FOR COUNTY TURN LANE PERMIT SYSTEM ONLY

ANOKA COUNTY ENGINEER DATE

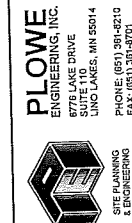

DRAWN BY: JAG
 AG NO: 23-2722
 CHECK BY: MGA
 DATE: 03/20/24

PLOWE ENGINEERING, INC.
 8776 LAKE DRIVE
 SUITE 110
 LINDA LAKE, MN 55914
 PHONE: (855) 381-8910
 FAX: (855) 381-8911

NO.	DATE	DESCRIPTION
1	04.15.24	RFC & CCWD COMMENTS
2	04.17.24	ADDITIONAL TURN LANE DETAIL
3		
4		
5		
6		
7		
8		

I hereby certify that this plan was prepared by me or under my direct supervision and that I am a duly licensed professional engineer under the laws of the State of Minnesota.

PRELIMINARY
 ADAM GINKEL
 Date: 04.17.2024 License No. 48963

XYLITE ST NE
 SOUTHBOUND RIGHT TURN LANE

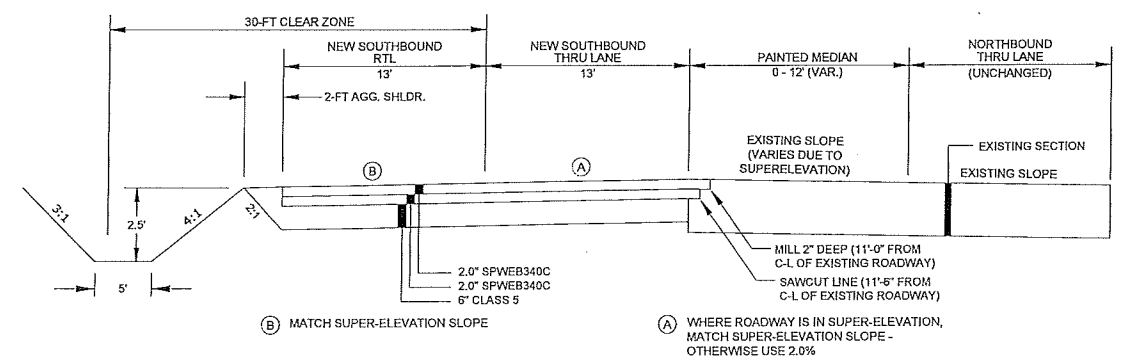

- NOTES
1. ALL INSTALLATIONS SHALL BE IN ACCORDANCE WITH MNDOT SPECIFICATIONS (LATEST EDITION)
 2. ALL DISTURBED SOIL WITHIN COUNTY RIGHT-OF-WAY MUST BE SEEDED (MNDOT 25-141) & MULCHED (TYPE 1, DISC ANCHORED)
 3. USE ALL STRAW FIBER BLANKET FOR DITCH SLOPES OF 3:1 OR GREATER
 4. PAVEMENT MARKINGS SHALL BE EPOXY
 5. CONTRACTOR TO CONTACT ANOKA COUNTY PERMITS SECTION AT (763) 324-3176 TO OBTAIN THE RIGHT-OF-WAY PERMIT.

XYLITE ST NE
 NORTHBOUND LEFT TURN LANE

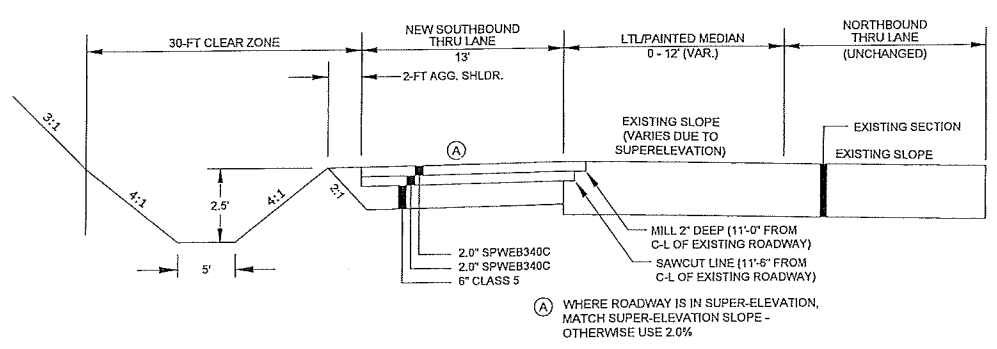

- NOTES
1. ALL INSTALLATIONS SHALL BE IN ACCORDANCE WITH MNDOT SPECIFICATIONS (LATEST EDITION)
 2. ALL DISTURBED SOIL WITHIN COUNTY RIGHT-OF-WAY MUST BE SEEDED (MNDOT 25-141) & MULCHED (TYPE 1, DISC ANCHORED)
 3. USE ALL STRAW FIBER BLANKET FOR DITCH SLOPES OF 3:1 OR GREATER
 4. PAVEMENT MARKINGS SHALL BE EPOXY
 5. CONTRACTOR TO CONTACT ANOKA COUNTY PERMITS SECTION AT (763) 324-3176 TO OBTAIN THE RIGHT-OF-WAY PERMIT.

SWEDISH CHAPEL ESTATES
 HAM LAKE, MN
LEFT & RIGHT TURN LANE PLAN
 PREPARED FOR: MN DEVELOPMENTS, LLC

SHEET
C4.2

APPROVED FOR COUNTY TURN LANE ITEMS ONLY
 ANOKA COUNTY ENGINEER _____ DATE _____

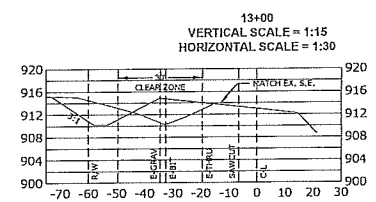
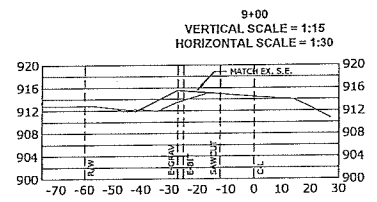
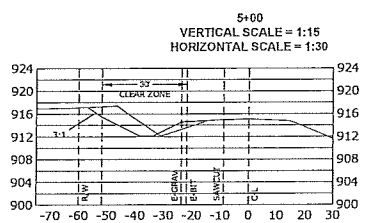
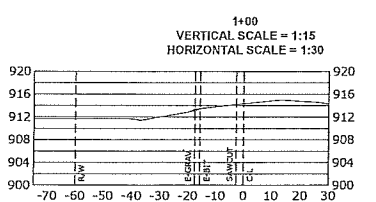
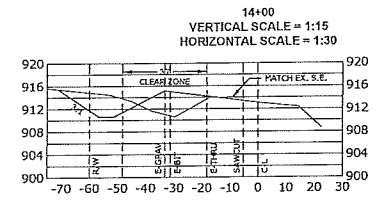
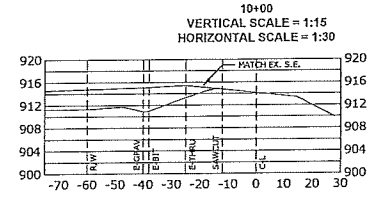
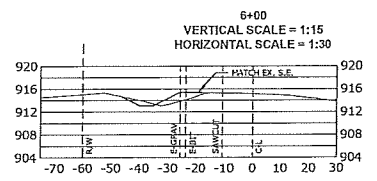
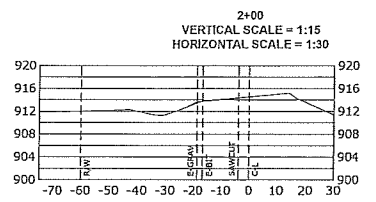
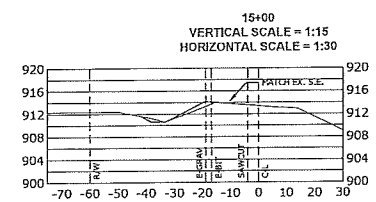
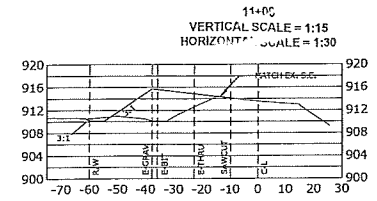
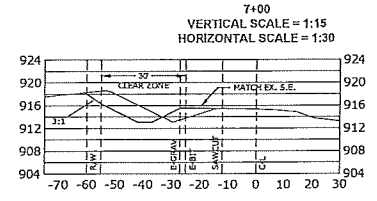
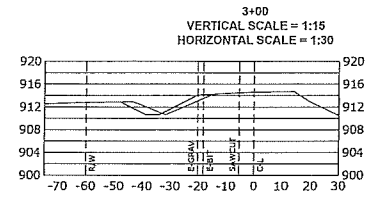
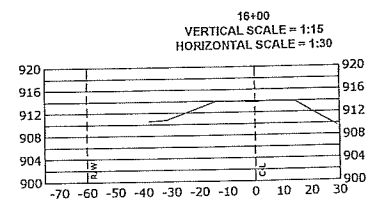
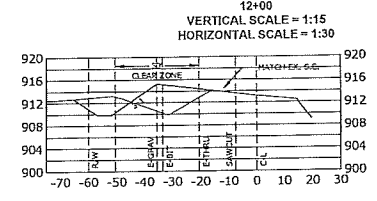
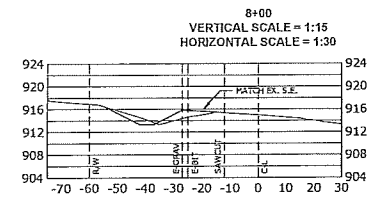
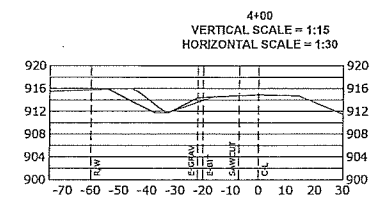

ALL GREEN AREA SLOPES ARE 4:1 UNLESS OTHERWISE NOTED
 S.E. = SUPER-ELEVATION

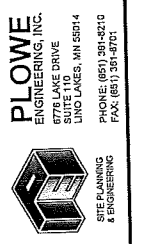

PLOWE ENGINEERING, INC.
 6772 LAKE DRIVE
 SUITE 10
 LIND LAKES, MN 55114
 PHONE: (951) 301-8210
 FAX: (951) 361-8711

DRAWN BY:	AG	
JOB NO.:	23-2122	
CHECK BY:	MGA	
DATE:	03/20/24	
NO.	DATE	DESCRIPTION
1	04-17-24	SHEET ADDED TO SET
2		
3		
4		
5		
6		
7		
8		

I hereby certify that this plan was prepared by me or under my direct supervision and that I am a duly licensed Professional Engineer under the laws of the State of Minnesota.
PRELIMINARY
 ADAM GINKEL
 Date: 04.17.2024 License No. 49983

SWEDISH CHAPEL ESTATES
 HAM LAKE, MN
LEFT & RIGHT TURN LANE PLAN
 PREPARED FOR: MN DEVELOPMENTS, LLC

SHEET
C4.3



NOTE: ANY SCHEDULING OF EQUIPMENT MUST BE DONE THROUGH WARNING LITES OF MN, INC- FRONT OFFICE 612-521-4200

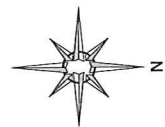

ARNT
 CONTACT: NICHOLAS ARNT
 PHONE: 651.426.1296
 PROJECT: SWEDISH CHAPPEL ESTATES
 START DATE: DURATION:
 WORK TYPE: FLAGGING SETUP
 HOURS OF OPERATION: 24-HOUR SETUP

AUTHOR: Mike Miller
 MN TCS CERT#: 2248
 MAP PAGE:
 CITY: HAM LAKE
 DATE:
 PAGE: 1 OF 1
 SCALE: NONE
 GOV. AGENCY:

WARNING LITES
 4700 LYNDALE AVE N
 MINNEAPOLIS, MN 55430
 TEL: 612-685-8273
 FAX: 612-521-0646
 mmiller@warninglitesmn.com

SUPPLEMENTAL SPECIAL CONDITIONS FOR

NEW STREET TIE-INS, TURN LANES, BYPASS LANES, & TEMPORARY ACCESS

PERMIT NUMBER: 24-452

PERMIT HOLDER: Arnt Construction

LOCATION: 2506 Swedish Dr NE

CITY: Ham Lake

DEVELOPMENT NAME: Swedish Chapel Estates

NEW STREET NAME:

ROADWAY IMPROVEMENTS:

RIGHT TURN LANE

LEFT TURN LANE

BYPASS LANE

Southbound

Northbound

Northbound

Shall notify the Anoka County Highway Department at least 36 hours prior to the commencement of work and upon completion at highwaypermits@anokacountymn.gov or 763-324-3176. Information needed for notification includes the permit number, date/time work is to be performed, and the traffic control contact.

TRAFFIC CONTROL

- All traffic control shall be in accordance with the most current version of the MN MUTCD and MnDOT Field Manual.
- At the new street tie-in, until paved, the permit holder shall provide a 75 foot-long, 1 ½” washed rock approach at the access to minimize the tracking of grading materials from the site onto the public highway.
- No stopping of traffic on the county highway system to allow trucks and/or equipment in or out of the new city street tie-in.
- If the need occurs to stop traffic during approved hours, a flagging operation shall be used.
- Where the new street tie-ins meet the county highway system, continuous cleanup operations are required at a minimum of once per day.
 - Additional cleanup operations may be required if conditions warrant.
 - Bare pavement and visible roadway striping shall be maintained.
 - If reports or incidents of buildup of material occur, access use shall be terminated by ACHD until clean up is completed.
- A stop sign shall be in place at the access to as they exit the site.
- There shall be no parking of trucks/equipment along the county highway system.
- The backing of trucks in and out of the site will not be allowed.
- The permit holder shall be responsible for repairing any/all damage to the county highway system.
- The permit holder shall be responsible for all restoration as the result of any damage to roadway/shoulder from use of access.
 - All costs associated with the removal of temporary access, repair to roadway/shoulder, and all restoration requirements shall be the responsibility of the permit holder.
- If turn lanes cannot be completed, including signing and striping, by October 15, then construction shall commence in the spring of the following year.

THIS PERMIT COVERS THE RIGHT OF WAY IN ANOKA COUNTY ONLY

ACHD reserves the right to make changes to these special conditions.

SUPPLEMENTAL SPECIAL CONDITIONS FOR

NEW STREET TIE-INS, TURN LANES, BYPASS LANES, & TEMPORARY ACCESS

SIGNING & STRIPING

- Developer/Contractor will be required to make the necessary pavement marking removals for the right turn lane.
- ACHD will perform the marking for the pavement marking removal limits. Contractor shall contact Logan Keehr at 763-324-3183 at least 48 hours in advance to schedule a time for staff to perform the markings.
- Developer/Contractor will be required to make the necessary pavement markings for the right turn lane. Contractor will perform the final pavement markings for the implementation of turn lane(s), and/or bypass lane(s). Contractor shall contact Logan Keehr at 763-324-3183.
- ACHD will perform spotting for the permanent striping. Contractor shall contact Logan Keehr at 763-324-3183.
- Contractor shall use paint type per the approved plan or epoxy if paint is not indicated on the approved plan and paint shall be in accordance with Mn/DOT's Pavement Marking Qualified Product List on permanent striping (see attached or go to www.dot.state.mn.us/trafficeng/qpl/pavementmarkings).
- Permanent striping shall occur by October 15, or temperatures maintain 40° F and rising, otherwise a Late Season Cold Weather Product shall be used (see attached or go to www.dot.state.mn.us/trafficeng/qpl/pavementmarkings).
- Contractor will perform all installations and maintenance of permanent signing. Contractor shall contact Mike Murphy at 763-324-3197 to coordinate the signing installations with the permanent striping.
- It will be the responsibility of the Developer/Contractor to monitor dates and temperatures regarding the progress of the street tie-ins, paving, and striping. No construction shall commence if the above dates and temperatures cannot be met for a complete project (being open to traffic with full striping and signing).



Anoka County

TRANSPORTATION DIVISION

Respectful, Innovative, Fiscally Responsible

Highway

Transit

Surveyor

GIS

Fleet

Joe MacPherson, P.E.
Chief Officer, Transportation, County Engineer

Jerry Auge, P.E.
Department Director, Assistant County Engineer

EXCAVATOR AND OPERATOR NOTICE

This notice is for all excavators and operators applying for permits involving excavations - your obligations to comply with Minnesota State Statutes 216D are attached to this notice.

This notice is a requirement of State Statute 216D.02; Notice to Excavators and Operators.

Our Passion Is Your Safe Way Home

1440 Bunker Lake Boulevard N.W. ▲ Andover, MN 55304-4005
Office: 763-324-3100 ▲ Fax: 763-324-3020 ▲ www.anokacounty.us/highway

Affirmative Action / Equal Opportunity Employer

216D.03 NOTIFICATION CENTER.

Subdivision 1. **Participation.** An operator shall participate in and share in the costs of one statewide notification center operated by a vendor selected under subdivision 2.

Subd. 2. **Establishment of notification center; rules.** (a) The notification center services must be provided by a nonprofit corporation approved in writing by the commissioner. The nonprofit corporation must be governed by a board of directors of up to 20 members, one of whom is the director of the Office of Pipeline Safety. The other board members must represent and be elected by operators, excavators, and other persons eligible to participate in the center. In deciding to approve a nonprofit corporation, the commissioner shall consider whether it meets the requirements of this paragraph and whether it demonstrates that it has the ability to contract for and implement the notification center service.

(b) The commissioner shall adopt rules:

(1) establishing a notification process and competitive bidding procedure for selecting a vendor to provide the notification service;

(2) governing the operating procedures and technology needed for a statewide notification center; and

(3) setting forth the method for assessing the cost of the service among operators.

(c) The commissioner shall select a vendor to provide the notification center service. The commissioner may advertise for bids as provided in section 16C.06, subdivisions 1 and 2, and base the selection of a vendor on best value as provided in section 16C.06, subdivision 6. The commissioner shall select and contract with the vendor to provide the notification center service, but all costs of the center must be paid by the operators. The commissioner may at any time appoint a task force to advise on the renewal of the contract or any other matter involving the center's operations.

(d) An operator may submit a bid and be selected to contract to provide the notification center service under paragraph (a) or (c). The commissioner shall annually review the services provided by the nonprofit corporation approved under paragraph (a) or the vendor selected under paragraph (c).

Subd. 3. **Cooperation with local government.** In establishing operating procedures and technology for the statewide notification center, the board of directors or the commissioner must work in cooperation with the League of Minnesota Cities, the Association of Minnesota Counties, and the Township Officers' Association. The purpose of this cooperation is to maximize the participation of local governmental units that issue permits for activities involving excavation to assure that excavators receive notice of and comply with the requirements of sections 216D.01 to 216D.07.

Subd. 4. **Notice to local government.** The notification center shall provide local governmental units with a master list, by county, of the operators in the county who are participants in the notification center, and the telephone number and mailing address of the notification center.

History: 1987 c 353 s 9; 1997 c 187 art 1 s 15; 1998 c 386 art 2 s 69

216D.04 EXCAVATION; LAND SURVEY.

Subdivision 1. **Notice required; contents.** (a) Except in an emergency, an excavator shall and a land surveyor may contact the notification center and provide notice at least 48 hours, excluding Saturdays, Sundays, and holidays and not more than 14 calendar days before beginning any excavation or boundary survey. An excavation or boundary survey begins, for purposes of this requirement, the first time excavation or a boundary survey occurs in an area that was not previously identified by the excavator or land surveyor in the notice.

(b) The notice may be oral or written, and must contain the following information:

- (1) the name of the individual providing the notice;
- (2) the precise location of the proposed area of excavation or survey;
- (3) the name, address, and telephone number of the individual or individual's company;
- (4) the field telephone number, if one is available;
- (5) the type and extent of the activity;
- (6) whether or not the discharge of explosives is anticipated;
- (7) the date and time when the excavation or survey is to commence; and
- (8) the estimated duration of the activity.

Subd. 1a. **Plans for excavation.** (a) Any person, prior to soliciting bids or entering into a contract for excavation, shall provide a proposed notice to the notification center to obtain from the affected operators of underground facilities the type, size, and general location of underground facilities. Affected operators shall provide the information within 15 working days. An operator who provides information to a person who is not a unit of government may indicate any portions of the information which are proprietary and may require the person to provide appropriate confidentiality protection. The information obtained from affected operators must be submitted on the final drawing used for the bid or contract and must depict the utility quality level of that information. This information must be updated not more than 90 days before completion of the final drawing used for the bid or contract.

(b) This subdivision does not apply to bids and contracts for:

- (1) routine maintenance of underground facilities or installation, maintenance, or repair of service lines;
- (2) excavation for operators of underground facilities performed on a unit of work or similar basis; or
- (3) excavation for home construction and projects by home owners.

(c) A person required by this section to show existing underground facilities on its drawings shall conduct one or more preliminary design meetings during the design phase to communicate the project design and coordinate utility relocation. Affected facility operators shall attend these meetings or make other arrangements to provide information.

(d) A person required by this section to show existing underground facilities on its drawings shall conduct one or more preconstruction meetings to communicate the project design and coordinate utility relocation. Affected facility operators and contractors shall attend these meetings or make other arrangements to provide information.

(e) This subdivision does not affect the obligation to provide a notice of excavation as required under subdivision 1.

Subd. 2. Duties of notification center; regarding notice. The notification center shall assign an inquiry identification number to each notice and retain a record of all notices received for at least six years. The center shall immediately transmit the information contained in a notice to every operator that has an underground facility in the area of the proposed excavation or boundary survey.

Subd. 3. Locating underground facility; operator. (a) Prior to the excavation start time on the notice, an operator shall locate and mark or otherwise provide the approximate horizontal location of the underground facilities of the operator and provide readily available information regarding the operator's abandoned and out-of-service underground facilities as shown on maps, drawings, diagrams, or other records used in the operator's normal course of business, without cost to the excavator. The excavator shall determine the precise location of the underground facility, without damage, before excavating within two feet of the marked location of the underground facility.

(b) Within 96 hours or the time specified in the notice, whichever is later, after receiving a notice for boundary survey from the notification center, excluding Saturdays, Sundays, and holidays, unless otherwise agreed to between the land surveyor and operator, an operator shall locate and mark or otherwise provide the approximate horizontal location of the underground facilities of the operator, without cost to the land surveyor.

(c) For the purpose of this section, the approximate horizontal location of the underground facilities is a strip of land two feet on either side of the underground facilities.

(d) Markers used to designate the approximate location of underground facilities must follow the current color code standard used by the American Public Works Association.

(e) If the operator cannot complete marking of the excavation or boundary survey area before the excavation or boundary survey start time stated in the notice, the operator shall promptly contact the excavator or land surveyor.

(f) After December 31, 1998, operators shall maintain maps, drawings, diagrams, or other records of any underground facility abandoned or out-of-service after December 31, 1998.

(g) An operator or other person providing information pursuant to this subdivision is not responsible to any person, for any costs, claims, or damages for information provided in good faith regarding abandoned, out-of-service, or private or customer-owned underground facilities.

Subd. 4. Locating underground facility; excavator or land surveyor. (a) The excavator or land surveyor shall determine the precise location of the underground facility, without damage, before excavating within two feet on either side of the marked location of the underground facility.

(b) If the excavator or land surveyor cancels the excavation or boundary survey, the excavator or land surveyor shall cancel the notice through the notification center.

(c) The notice is valid for 14 calendar days from the start time stated on the notice. If the activity will continue after the expiration time, then the person responsible for the activity shall serve an additional notice at least 48 hours, excluding Saturdays, Sundays, and holidays, before the expiration time of the original notice, unless the excavator makes arrangements with the operators affected to periodically verify or refresh the marks, in which case the notice is valid for six months from the start time stated on the notice.

(d) The excavator is responsible for reasonably protecting and preserving the marks until no longer required for proper and safe excavation near the underground facility. If the excavator has reason to believe the marks are obliterated, obscured, missing, or incorrect, the excavator shall notify the facility operator or notification center in order to have an operator verify or refresh the marks.

History: *1987 c 353 s 10; 1992 c 493 s 5; 1993 c 341 art 1 s 21; 1997 c 196 s 1; 1998 c 348 s 1-3; 2004 c 163 s 2-6*

216D.05 PRECAUTIONS TO AVOID DAMAGE.

An excavator shall:

- (1) plan the excavation to avoid damage to and minimize interference with underground facilities in and near the construction area;
- (2) use white markings for proposed excavations except where it can be shown that it is not practical;
- (3) maintain a clearance between an underground facility and the cutting edge or point of any mechanized equipment, considering the known limit of control of the cutting edge or point to avoid damage to the facility;
- (4) provide support for underground facilities in and near the construction area, including during backfill operations, to protect the facilities; and
- (5) conduct the excavation in a careful and prudent manner.

History: *1987 c 353 s 11; 1998 c 348 s 4; 2004 c 163 s 7*

216D.06 DAMAGE TO FACILITY.

Subdivision 1. **Notice; repair.** (a) If any damage occurs to an underground facility or its protective covering, the excavator shall notify the operator promptly. When the operator receives a damage notice, the operator shall promptly dispatch personnel to the damage area to investigate. If the damage results in the escape of any flammable, toxic, or corrosive gas or liquid or endangers life, health, or property, the excavator responsible shall immediately notify the operator and the 911 public safety answering point, as defined in section 403.02, subdivision 19, and take immediate action to protect the public and property. The excavator shall also attempt to minimize the hazard until arrival of the operator's personnel or until emergency responders have arrived and completed their assessment. The 911 public safety answering point shall maintain a response plan for notifications generated by this section.

(b) An excavator shall delay backfilling in the immediate area of the damaged underground facilities until the damage has been investigated by the operator, unless the operator authorizes otherwise. The repair of damage must be performed by the operator or by qualified personnel authorized by the operator.

(c) An excavator who knowingly damages an underground facility, and who does not notify the operator as soon as reasonably possible or who backfills in violation of paragraph (b), is guilty of a misdemeanor.

Subd. 2. **Cost reimbursement.** (a) If an excavator damages an underground facility, the excavator shall reimburse the operator for the cost of necessary repairs, and for a pipeline the cost of the product that was being carried in the pipeline and was lost as a direct result of the damage.

(b) Reimbursement is not required if the damage to the underground facility was caused by the sole negligence of the operator or the operator failed to comply with section 216D.04, subdivision 3.

Subd. 3. **Prima facie evidence of negligence.** It is prima facie evidence of the excavator's negligence in a civil court action if damage to the underground facilities of an operator resulted from excavation, and the excavator failed to give an excavation notice under section 216D.04 or provide support as required by section 216D.05.

History: 1987 c 353 s 12; 1999 c 43 s 1

216D.07 EFFECT ON LOCAL ORDINANCES.

(a) Sections 216D.01 to 216D.07 do not affect or impair local ordinances, charters, or other provisions of law requiring permits to be obtained before excavating.

(b) A person with a permit for excavation from the state or a public agency is subject to sections 216D.01 to 216D.07. The state or public agency that issued a permit for excavation is not liable for the actions of an excavator who fails to comply with sections 216D.01 to 216D.07.

History: *1987 c 353 s 13*

CHAPTER 7560
OFFICE OF PIPELINE SAFETY
EXCAVATION NOTICE SYSTEM

- 7560.0100 DEFINITIONS.
- 7560.0125 ABANDONED AND OUT-OF-SERVICE FACILITIES.
- 7560.0150 PUBLIC RIGHT-OF-WAY MAPPING AND INSTALLATION.
- 7560.0225 EXCAVATOR RESPONSIBILITIES REGARDING A LOCATE.
- 7560.0250 LOCATE STANDARDS.
- 7560.0300 OPERATOR PARTICIPATES AND SHARES COSTS.
- 7560.0325 EMERGENCY EXCAVATION NOTICES.
- 7560.0350 EXCAVATION NOTICE REQUESTING MEET.
- 7560.0375 LOCATING A SERVICE LATERAL.
- 7560.0400 CITATIONS.
- 7560.0500 RESPONSE OPTIONS.
- 7560.0600 DIRECTOR REVIEW.
- 7560.0700 CONSENT ORDER.
- 7560.0800 CIVIL PENALTIES.

7560.0100 DEFINITIONS.

Subpart 1. **Scope.** The terms used in this chapter have the meanings given them. Terms not defined in this part have the meanings given them in Minnesota Statutes, section 216D.01.

Subp. 1a. **Abandoned facility.** "Abandoned facility" means an underground facility that is no longer in service and is physically disconnected from a portion of the operating facility that is in use or still carries service. An abandoned facility has been deemed abandoned by the operator.

Subp. 2. **Director.** "Director" means the director of the Office of Pipeline Safety of the Minnesota Department of Public Safety.

Subp. 3. **Good cause to believe.** "Good cause to believe" means grounds put forth in good faith that are not arbitrary, irrational, unreasonable, or irrelevant and that are based on at least one of the following sources:

- A. information from a person;
- B. facts supplied by the notification center defined in Minnesota Statutes, section 216D.01, subdivision 8;
- C. facts of which the director or an agent of the director has personal knowledge; and
- D. information provided by excavators or operators.

Subp. 4. **Locate.** "Locate" means an operator's markings of an underground facility.

Subp. 5. [Renumbered as subp 8]

Subp. 5a. [Renumbered as subp 9]

Subp. 6. [Renumbered as subp 11]

7560.0125 EXCAVATION NOTICE SYSTEM

2

Subp. 7. **Meet.** When used as a noun in this chapter, "meet" refers to a meeting at the site of proposed excavation requested at the time of notice by the excavator with all affected underground facility operators to further clarify the precise geographic location of excavation, schedule locating, propose future contacts, and share other information concerning the excavation and facilities.

Subp. 8. **Office.** "Office" means the Office of Pipeline Safety of the Minnesota Department of Public Safety.

Subp. 9. **Out-of-service facility.** "Out-of-service facility" means an underground facility that is no longer maintained and is not intended for future use, but has not been deemed abandoned. An out-of-service facility may still be connected to a portion of the operating facility that is in use or still carries service.

Subp. 10. **Public right-of-way.** "Public right-of-way" means the area on, below, or above a public roadway, highway, street, cartway, bicycle lane, and sidewalk in which a government unit has an interest, including other rights-of-way dedicated for travel purposes and utility easements of government units.

Subp. 11. **Remuneration.** "Remuneration" means direct or indirect compensation or consideration paid to the person or the person's agent, employer, employee, subcontractor, or contractor. A person who excavates as part of the person's duties as an employee, employer, agent, subcontractor, or contractor is considered to be acting for remuneration.

Subp. 12. **Service lateral.** "Service lateral" means an underground facility that is used to transmit, distribute, or furnish gas, electricity, communications, or water from a common source to an end-use customer. A service lateral is also an underground facility that is used in the removal of wastewater from a customer's premises.

Statutory Authority: *MS s 14.06; 216D.08; 299F.56; 299F.60; 299F.641; 299J.04*

History: *16 SR 135; 24 SR 448; 29 SR 1503*

Published Electronically: *July 20, 2005*

7560.0125 ABANDONED AND OUT-OF-SERVICE FACILITIES.

Subpart 1. **Duty of operators to provide readily available information.** Operators shall provide readily available information, as shown on maps, drawings, diagrams, or other records used in the normal course of business, on the approximate location of abandoned and out-of-service facilities to an excavator by the excavation date and time noted on the excavation or location notice unless otherwise agreed between the excavator and the operator. An operator fulfills an obligation to provide information on these facilities by doing one or more of the following:

A. locating and marking the approximate location of the facility according to the current color code standard used by the American Public Works Association, as required in Minnesota Statutes, section 216D.04, subdivision 3, with an abandoned or out-of-service facility identified by an uppercase A surrounded by a circle;

B. providing informational flags at the area of proposed excavation;

C. communicating information verbally; or

D. providing copies of maps, diagrams, or records.

Subp. 2. **Duty to notify operator.** An excavator shall notify the operator:

A. before moving, removing, or otherwise altering a facility that is thought to be abandoned or out of service; or

B. if damage to the facility occurs, pursuant to Minnesota Statutes, section 216D.01, subdivision 2.

Subp. 3. **Verification of abandoned or out-of-service facility.** Upon receipt of notification by an excavator pursuant to subpart 2, an operator shall verify that an underground facility is abandoned or out of service, by either reference to installation records, testing, or other comparable standard of verification, before an excavator is allowed to move, remove, or otherwise alter an underground facility.

Subp. 4. **Liability.** An operator providing information pursuant to Minnesota Statutes, section 216D.04, subdivision 3, is not responsible to any person for any costs, claims, or damages for information provided in good faith regarding abandoned and out-of-service underground facilities.

Statutory Authority: *MS s 14.06; 216D.08; 299J.04; 299F.60*

History: *24 SR 448*

Published Electronically: *July 20, 2005*

7560.0150 PUBLIC RIGHT-OF-WAY MAPPING AND INSTALLATION.

Subpart 1. **Duty of operator to map.** After December 31, 2005, an operator shall maintain a map, a diagram, a drawing, or geospatial information regarding the location of its underground facility within a public right-of-way installed after that date.

Subp. 2. **Duty to install locating wire.** After December 31, 2005, an operator shall install a locating wire or have an equally effective means of marking the location of each nonconductive underground facility within a public right-of-way installed after that date. This requirement does not apply when making minor repairs to an existing nonconductive facility. As applied to this chapter, "minor repairs" means repairs to or partial replacement of portions of existing service laterals located within a public right-of-way for purposes of routine maintenance and upkeep.

Statutory Authority: *MS s 299J.04*

History: *29 SR 1503*

Published Electronically: *July 20, 2005*

7560.0200 [Repealed, 24 SR 448]

Published Electronically: *July 20, 2005*

7560.0225 EXCAVATOR RESPONSIBILITIES REGARDING A LOCATE.

Subpart 1. [Repealed, 29 SR 1503]

Subp. 2. **Responsibility to protect and preserve.** The excavator is responsible for reasonably protecting and preserving a locate until no longer required for proper and safe excavation near the underground facility. If the excavator has reason to believe a locate is obliterated, obscured, missing, or incorrect, the excavator shall notify the facility operator or notification center in order to have an operator verify, refresh, or re-mark the locate.

7560.0250 EXCAVATION NOTICE SYSTEM

4

Subp. 3. **Use of locate.** A locate is valid for 14 days from the excavation commencement time stated on the excavation or location notice, unless the excavator has made previous arrangements with the operators affected to periodically verify, refresh, or re-mark the locate.

Statutory Authority: *MS s 14.06; 216D.08; 299J.04; 299F.60*

History: *24 SR 448; 29 SR 1503*

Published Electronically: *July 20, 2005*

7560.0250 LOCATE STANDARDS.

Subpart 1. **Facility locate.** Unless otherwise agreed to between the excavator and operator, an operator shall locate an underground facility using stakes, flags, paint, or other suitable materials in varying combinations dependent upon the surface. The locate must be in sufficient detail to clearly identify the approximate route of the underground facility. The locate must also include:

- A. name, abbreviation, or logo of the operator when more than one operator listed on the notice uses the same color markings;
- B. width of the underground facility if it is greater than eight inches; and
- C. number of underground facilities if greater than one.

Subp. 2. **Operator duties in no conflict situation.** After December 31, 2005, an operator who receives notice and determines that an underground facility is not in conflict with the proposed excavation shall complete one or more of the following:

- A. mark the area "NO" followed by the operator's name, abbreviation, or logo in the color code of the underground facility not in conflict;
- B. place a clear plastic flag at the area that:
 - (1) states "N/C" or "NO CONFLICT" in lettering matching the color code of the underground facility that is not in conflict; and
 - (2) includes the operator's name, abbreviation, or logo, the date, a contact telephone number, and the ticket number; or
- C. contact the notification center through procedures required by the notification center and indicate that there are no underground facilities in conflict with the proposed excavation and that no markings or flags were left at the proposed excavation site.

Subp. 3. **Placement of flags or markings.** If using N/C (no conflict) flags or markings pursuant to subpart 2, an operator shall place the flags or markings in a location that can be readily observed by an excavator. When an area of proposed excavation is delineated by the use of white markings, an operator shall place the N/C flags or markings within, or as near as practicable to, the delineated area.

Subp. 4. **Duties of notification center.** After December 31, 2005, the notification center shall make the information received under subpart 2 available to the excavator before the start date and time on the notice. The notification center may fulfill this requirement by making the information accessible through one or more Internet addresses, by transmitting the information to a continuously working facsimile machine maintained by the excavator, or by other methodology developed by the notification center. The notification center shall make available the information received by operators pursuant to this section through

an electronic means. The notification center is not required by this subpart to contact an excavator verbally via telephone.

Statutory Authority: *MS s 299J.04*

History: *29 SR 1503*

Published Electronically: *July 20, 2005*

7560.0300 OPERATOR PARTICIPATES AND SHARES COSTS.

An operator shall participate in and share the costs of the one call excavation notice system by:

- A. submitting the information required by the notification center to allow the center to notify the operator of excavation activity;
- B. updating the information provided to the notification center on a timely basis;
- C. installing and paying for equipment reasonably requested by the notification center to facilitate receipt of notice of excavation from the center;
- D. paying the costs charged by the notification center on a timely basis; and
- E. receiving and responding to excavation notices, including emergency notices, as required by Minnesota Statutes, chapter 216D.

Statutory Authority: *MS s 14.06; 216D.08; 299F.56; 299F.641*

History: *16 SR 135*

Published Electronically: *July 20, 2005*

7560.0325 EMERGENCY EXCAVATION NOTICES.

Subpart 1. **Duty of excavator to provide notice.** An excavator shall provide notice to the notification center before commencing an emergency excavation, unless subpart 2 applies. All emergency notices, regardless whether made prior to excavation, must be verbal or in a manner accepted by the notification center. In addition to the information required by the notification center, the notice must also contain:

- A. a description of the situation requiring the emergency excavation;
- B. the precise location of the proposed area of the emergency excavation;
- C. at least one continuously staffed telephone number where the excavator can be contacted by the operator throughout the emergency; and
- D. the excavation start date and time if the need for excavation is not immediate.

Subp. 2. **Excavating before notice.** If an emergency is such that providing notice or waiting for an operator would result in an undue risk to life, health, or significant loss of property, the excavator may excavate without providing prior notice or waiting for an operator to mark an underground facility. In this situation, the excavator shall provide notice as soon as practicable and take all reasonable precautions to avoid or minimize damage. Excavation prior to notice under this subpart does not relieve an excavator from any responsibility for damage to an underground facility pursuant to Minnesota Statutes, section 216D.06.

Subp. 3. **Emergency notice requesting immediate response.** Upon receiving an emergency excavation notice requesting an immediate response, an operator shall:

7560.0350 EXCAVATION NOTICE SYSTEM

6

A. attempt to contact the excavator within one hour at the telephone number provided in subpart 1, item C, to provide any information concerning facilities at or near the area of excavation including an anticipated response time; and

B. locate and mark the underground facility within three hours of notice unless:

- (1) otherwise agreed between the parties;
- (2) the operator notifies the excavator that not locating does not present an immediate danger to life or health, or a significant loss of property; or
- (3) there is an event or situation that cannot be reasonably anticipated or controlled by the operator.

Subp. 4. **Emergency notice requesting scheduled response.** Upon receiving an emergency excavation notice that does not require an immediate response, and before the scheduled excavation start date and time, an operator shall:

A. locate and mark the underground facility, unless otherwise agreed between the parties; or

B. notify the excavator at the telephone number provided in subpart 1, item C, that there is not an underground facility within the area of proposed excavation.

For purposes of this subpart, a requested start time of three hours or less from the time notice is provided to the center is considered an emergency notice requesting immediate response under subpart 3.

Statutory Authority: *MS s 299J.04*

History: *29 SR 1503*

Published Electronically: *July 20, 2005*

7560.0350 EXCAVATION NOTICE REQUESTING MEET.

Subpart 1. **Excavator duties.** When requesting a meet through the notification center, an excavator must provide at least one contact name and telephone number to assist in facilitating the meet. An excavator shall contact the notification center to cancel or reschedule the meet and the notification center shall relay this information to the affected operators. When a meet is requested, an excavator's notice must include the entire geographic area of the proposed excavation and the specific location of the meet. This part does not relieve an excavator from the duty to provide a precise geographic location of the proposed area of excavation, or to use white markings except where it can be shown that to do so is not practical.

Subp. 2. **Operator duties.** When a meet is requested, an affected operator shall make a reasonable effort to attend the meet at the proposed date and time, or contact the excavator before the meet and reschedule for a mutually agreed date and time.

Subp. 3. **Excavation start date and time.** When a meet is requested, the meet date and time must be at least 48 hours after notice is provided, excluding Saturdays, Sundays, and holidays, and the excavation start date and time must be at least 24 hours after the proposed meet date and time specified on the notice, excluding Saturdays, Sundays, and holidays. This subpart does not apply if these matters are provided for in a written agreement with all affected operators.

Subp. 4. **Meet request documentation.** An excavator shall maintain written documentation of each meet with an underground facility operator or representative. This documentation must be kept for the duration of the excavation conducted under the notice. The documentation must include:

- A. the date and time of each meet;
- B. the names, company affiliations, and contact information of the attendees of each meet;
- C. a diagram, sketch, or description of the precise excavation locations, dates, and times; and
- D. the agreed schedule of any future meets or communications.

Statutory Authority: *MS s 299J.04*

History: *29 SR 1503*

Published Electronically: *July 20, 2005*

7560.0375 LOCATING A SERVICE LATERAL.

Subpart 1. **Operator duties.** Unless otherwise agreed, an underground facility operator shall locate a service lateral before the start date and time on the notice and in accordance with items A through C:

A. An operator of a natural gas, propane, or electric facility shall locate a service lateral up to the meter or the connection to a customer's underground facility, whichever is closer to the end-use customer. If the meter or connection to the customer's underground facility is within a public right-of-way, at a minimum the operator shall locate that portion of the service lateral within the public right-of-way up to the point where the service lateral first leaves the public right-of-way.

B. An operator of a communication facility shall locate a service lateral up to the entry of the first building. If the service lateral does not enter a building, the operator shall locate up to the utilization equipment, fence, or wall that surrounds the equipment.

C. After December 31, 2005, an operator of a sewage or water facility, at a minimum, shall locate that portion of the service lateral within a public right-of-way installed after that date up to the point where the service lateral first leaves the public right-of-way. The operator shall either locate or provide information as shown on maps, drawings, diagrams, or other records, on the location of a sewer or water service lateral installed before January 1, 2006. If no information is available on a sewer or water service lateral installed before January 1, 2006, then notifying the excavator that no information exists fulfills the requirements of this section.

Subp. 2. **Exception.** An operator is not required to locate a service lateral of a customer who currently participates in the statewide notification system, provided the customer and operator mutually agree that the customer will assume locate responsibilities. The agreement must be in writing.

Statutory Authority: *MS s 299J.04*

History: *29 SR 1503*

Published Electronically: *July 20, 2005*

7560.0400 CITATIONS.

Subpart 1. **Notice of violation.** The office shall issue a notice of probable violation when the office has good cause to believe a violation of Minnesota Statutes, sections 216D.01 to 216D.09 or this chapter has occurred.

Subp. 2. **Contents of notice of violation.** A notice of violation must include:

7560.0500 EXCAVATION NOTICE SYSTEM

8

- A. a statement of the statute or rule allegedly violated by the person and a description of the evidence on which the allegation is based;
- B. notice of response options available to the person cited;
- C. notice that the person has 30 days in which to respond;
- D. notice that failure to respond within 30 days precludes administrative review under this chapter; and
- E. if a civil penalty is proposed, the amount of the proposed civil penalty and the maximum civil penalty applicable under law.

Subp. 3. **Receipt of notice.** The notice of violation is deemed received three days after mailing to the person's last known address.

Statutory Authority: *MS s 14.06; 216D.08; 299F.56; 299F.60; 299F.641; 299J.04*

History: *16 SR 135; 24 SR 448*

Published Electronically: *July 20, 2005*

7560.0500 RESPONSE OPTIONS.

The person shall respond to the notice of violation in the following way:

- A. When the notice contains a proposed compliance order, the person shall:
 - (1) agree to the proposed compliance order;
 - (2) request the execution of a consent order;
 - (3) object to the proposed compliance order and submit written explanations, information, or other materials in answer to the allegations in the notice; or
 - (4) request the office to initiate a hearing under Minnesota Statutes, sections 14.50 to 14.69.
- B. When the notice contains a proposed civil penalty, the person shall:
 - (1) pay the penalty and close the case;
 - (2) submit an offer in compromise of the proposed civil penalty;
 - (3) submit a written explanation, information, or other material in answer to the allegations or in mitigation of the proposed civil penalty; or
 - (4) request the office to initiate a hearing under Minnesota Statutes, sections 14.50 to 14.69.
- C. Failure to respond in writing within 30 days precludes administrative review under this chapter. A final order will be issued and penalties will be forwarded for collection.

Statutory Authority: *MS s 14.06; 216D.08; 299F.56; 299F.60; 299F.641; 299J.04*

History: *16 SR 135; 24 SR 448*

Published Electronically: *July 20, 2005*

7560.0600 DIRECTOR REVIEW.

If the person objects to the proposed civil penalty or compliance order and submits written explanations, information, or other materials in response to a notice of violation, within the time specified in part 7560.0500, the director shall review the submissions and determine whether to negotiate further, to change or withdraw the notice of violation, or to initiate a hearing under Minnesota Statutes, sections 14.50 to 14.69.

Statutory Authority: *MS s 14.06; 216D.08; 299F.56; 299F.60; 299F.641; 299J.04*

History: *16 SR 135; 24 SR 448*

Published Electronically: *July 20, 2005*

7560.0700 CONSENT ORDER.

An executed consent order must contain:

- A. an admission by the person of the jurisdictional facts;
- B. a waiver of further procedural steps and the right to seek judicial or administrative review or otherwise challenge or contest the validity of the consent order; and
- C. an agreement that the notice of violation may be used to construe the terms of the consent order.

Statutory Authority: *MS s 14.06; 216D.08; 299F.56; 299F.641*

History: *16 SR 135*

Published Electronically: *July 20, 2005*

7560.0800 CIVIL PENALTIES.

Subpart 1. **Proceedings against excavators.** When the office has good cause to believe that an excavator is engaging or has engaged in conduct that violates Minnesota Statutes, section 216D.04, subdivision 1, 2, or 3; 216D.05, clause (1), (2), (3), or (4); or 216D.06, subdivision 1, or a rule adopted under Minnesota Statutes, section 216D.08, subdivision 4, the office, if appropriate, shall negotiate a civil penalty under Minnesota Statutes, section 216D.08, subdivision 2. A penalty imposed under Minnesota Statutes, section 216D.08, is subject to the contested case and judicial review provisions of Minnesota Statutes, chapter 14. An operator who engages or has engaged in excavation that violates Minnesota Statutes, chapter 216D, is subject to the proceedings specified in subpart 2 and is subject to the penalties specified in subpart 4, item B or C.

Subp. 2. **Proceedings against underground facility operators.** The office may negotiate a civil penalty under item A or B.

A. When the office has good cause to believe that an underground facility operator, other than an operator set forth in item B, is engaging or has engaged in conduct that violates Minnesota Statutes, sections 216D.01 to 216D.07, or a rule adopted under Minnesota Statutes, section 216D.08, subdivision 4, the office, if appropriate, shall negotiate a civil penalty under Minnesota Statutes, section 216D.08, subdivision 2. A penalty imposed under Minnesota Statutes, section 216D.08, is subject to the contested case and judicial review provisions of Minnesota Statutes, chapter 14.

7560.0800 EXCAVATION NOTICE SYSTEM

10

B. When the office has good cause to believe that an operator who engages in the transportation of gas or hazardous liquids or who owns or operates a gas or hazardous liquid pipeline facility is engaging or has engaged in conduct that violates Minnesota Statutes, sections 299F.56 to 299F.641, or a rule adopted under Minnesota Statutes, section 299F.60, subdivision 5, the office, if appropriate, shall negotiate a civil penalty under Minnesota Statutes, section 299F.60, subdivision 2. A penalty imposed under Minnesota Statutes, section 299F.60, is subject to the contested case and judicial review provisions of Minnesota Statutes, chapter 14.

Subp. 3. **Assessment considerations.** In assessing a civil penalty under this part, the office shall consider the following factors:

- A. the nature, circumstances, and gravity of the violation;
- B. the degree of the person's culpability;
- C. the person's history of previous offenses;
- D. the person's ability to pay;
- E. good faith on the part of the person in attempting to remedy the cause of the violation;
- F. the effect of the penalty on the person's ability to continue in business; and
- G. past reports of damage to an underground facility by a person.

Subp. 4. **Maximum penalties.** For the purposes of this part, penalties imposed under this part must not exceed the limits in items A to C.

A. Penalties imposed against excavators must not exceed \$1,000 for each violation per day of violation.

B. Penalties imposed against underground facility operators, other than an operator set forth in item C, must not exceed \$1,000 for each violation per day of violation.

C. Penalties imposed against an operator who engages in the transportation of gas or hazardous liquids or who owns or operates a gas or hazardous liquid pipeline facility must not exceed \$10,000 for each violation for each day that the violation persists, except that the maximum civil penalty must not exceed \$500,000 for a related series of violations.

Subp. 5. **Payment procedure.** The person shall pay a civil penalty that has been proposed, assessed, or compromised by submitting to the office a check or money order in the correct amount, payable to the commissioner of public safety.

Statutory Authority: *MS s 14.06; 216D.08; 299F.56; 299F.60; 299F.641; 299J.04*

History: *16 SR 135; 24 SR 448*

Published Electronically: *July 20, 2005*

Certificate Of Completion

Envelope Id: BADDA25B2E694976A46C1A89547C8105
 Subject: Nicholas J Arnt - ROW Permit Application
 Source Envelope:
 Document Pages: 34
 Certificate Pages: 4
 AutoNav: Enabled
 Envelopeld Stamping: Enabled
 Time Zone: (UTC-06:00) Central Time (US & Canada)

Status: Completed
 Envelope Originator:
 Highway Permits
 Anoka County Government Center
 2100 3rd Avenue
 Anoka, MN 55303
 highwaypermits@anokacountymn.gov
 IP Address: 75.168.94.76

Record Tracking

Status: Original 7/24/2024 11:30:13 AM	Holder: Highway Permits highwaypermits@anokacountymn.gov	Location: DocuSign
Security Appliance Status: Connected	Pool: StateLocal	
Storage Appliance Status: Connected	Pool: Anoka County	Location: DocuSign

Signer Events

Nicholas J Arnt
 narnt@arntco.com
 Security Level:
 DocuSign.email
 ID: 1
 7/24/2024 11:30:14 AM

Signature

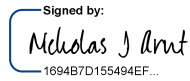
Signed by:

 1694B7D155494EF...
 Signature Adoption: Pre-selected Style
 Using IP Address: 75.168.94.76

Timestamp

Sent: 7/24/2024 11:30:13 AM
 Viewed: 7/24/2024 11:30:34 AM
 Signed: 7/24/2024 11:42:43 AM

Electronic Record and Signature Disclosure:

Accepted: 7/24/2024 11:30:34 AM
 ID: ba73d632-5085-4a48-abc8-6d254b849fe0

Susan Burgmeier
 Susan.Burgmeier@anokacountymn.gov
 Associate Traffic Technician
 Anoka County
 Signing Group: Highway Permits
 Security Level: Email, Account Authentication (Optional)

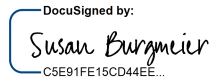
DocuSigned by:

 C5E91FE15CD44EE...
 Signature Adoption: Pre-selected Style
 Using IP Address: 156.98.106.245

Sent: 7/24/2024 11:42:46 AM
 Viewed: 7/24/2024 12:57:58 PM
 Signed: 7/25/2024 2:56:07 PM

Electronic Record and Signature Disclosure:

Accepted: 5/16/2024 12:16:58 PM
 ID: fc7e15b7-4a65-4808-bc1a-e7e4c2d90339

In Person Signer Events	Signature	Timestamp
Editor Delivery Events	Status	Timestamp
Agent Delivery Events	Status	Timestamp
Intermediary Delivery Events	Status	Timestamp
Certified Delivery Events	Status	Timestamp
Carbon Copy Events	Status	Timestamp

Carbon Copy Events	Status	Timestamp
Nicholas J Arnt narnt@arntco.com Vice President Arnt Construction Co Inc Security Level: Email, Account Authentication (Optional)	COPIED	Sent: 7/25/2024 2:56:10 PM
Electronic Record and Signature Disclosure: Not Offered via DocuSign		

Witness Events	Signature	Timestamp
----------------	-----------	-----------

Notary Events	Signature	Timestamp
---------------	-----------	-----------

Envelope Summary Events	Status	Timestamps
-------------------------	--------	------------

Envelope Sent	Hashed/Encrypted	7/24/2024 11:30:13 AM
Envelope Updated	Security Checked	7/24/2024 11:42:43 AM
Envelope Updated	Security Checked	7/25/2024 2:56:07 PM
Certified Delivered	Security Checked	7/24/2024 12:57:58 PM
Signing Complete	Security Checked	7/25/2024 2:56:07 PM
Completed	Security Checked	7/25/2024 2:56:10 PM

Payment Events	Status	Timestamps
----------------	--------	------------

Electronic Record and Signature Disclosure
--

ELECTRONIC RECORD AND SIGNATURE DISCLOSURE

The following information constitutes Anoka County's (we, us or Company) written notices or disclosures relating to your use of DocuSign in relation to Anoka County's license. Described below are the terms and conditions for providing notices and disclosures electronically through the DocuSign system. Please read the information below carefully and thoroughly, and if you agree to this Electronic Record and Signature Disclosure (ERSD), please confirm your agreement by selecting the check-box next to 'I agree to use electronic records and signatures' before clicking 'CONTINUE' within the DocuSign system.

Getting paper copies

At any time, you may request from us a paper copy of any record provided or made available electronically to you by us. You will have the ability to download and print documents we send to you through the DocuSign system during and immediately after the signing session and, if you elect to create a DocuSign account, you may access the documents for a limited period of time (30 days) after the documents are first sent to you. At any time, if you request paper copies of any documents, you may be charged a fee. You may request paper copies from us by following the procedure described below.

Withdrawing your consent

If you decide to receive notices, disclosures and documents from us electronically, you may change your mind and tell us that going forward you want to receive documents only in paper format. Please note, processing time will be slowed down dramatically as we will be required to print and send the document through the mail and await your return of the documents. The process to change the method of receipt is described below.

All notices and disclosures will be sent to you electronically

Upon your acceptance to receive electronic notifications, all required notices, disclosures, authorizations, acknowledgements, and other documents that are required to be provided or made available to you during the course of our relationship with you will be provided electronically through the DocuSign system. All of the required documents will be provided to you at the address that you have given us.

How to contact Anoka County:

You may change your preferred method of contact whether electronically, or paper copies, or change your email address. You may also request paper copies of certain information from us, or withdraw your prior consent to receive documents. Please use the contact information below for your request and in the body of your correspondence, identify your desired action. If you are

changing an email address, please include your prior email address as well as your new address. If you no longer wish to receive future documents in electronic format, please include that request in the body of your email.

Email: helpdesk@co.anoka.mn.us

Phone: (763)-324-4110

Address: Anoka County Government Center
Attn: Information Technology, #300
2100 3rd Avenue
Anoka, MN 55303

Required hardware and software

The minimum system requirements for using the DocuSign system may change over time. The current system requirements are found here: <https://support.docusign.com/guides/signer-guide-signing-system-requirements>.

ACKNOWLEDGEMENT

To confirm your access to the electronic notices and disclosures, which will be similar to other electronic notices and disclosures that we may provide to you, please acknowledge that you have read this ERSD by selecting the check-box next to ‘I agree to use electronic records and signatures’ before clicking ‘CONTINUE’ within the DocuSign system.

By selecting the check-box next to ‘I agree to use electronic records and signatures’, you confirm that:

- You can access and read this Electronic Record and Signature Disclosure; and
- You can print this Electronic Record and Signature Disclosure, or save or send this Electronic Record and Disclosure to a location where you can print it, for future reference and access; and
- Until or unless you notify Anoka County as described above, you consent to receive exclusively through electronic means all notices, disclosures, authorizations, acknowledgements, and other documents that are required to be provided or made available to you by Anoka County during the course of your relationship with Anoka County.