

MAIN PANEL:171-1081-504

COBALT TS2 TYPE 2 CONTROLLER WITH:

CONTROLLER PART # F51674

- CONFIGURATION: L3604
- SOFTWARE: EOS
- ETHERNET MODULE
- OVERLAPS
  - A =
  - B =
  - C =
  - D =
  - E =
  - F =
  - G =
  - H =
- TELEMETRY MODULE
- INTERNAL RS-232 TELEMETRY

LEGEND

BIU	BUS INTERFACE UNIT
BU()	C/C, BIU ()
CB()	CIRCUIT BREAKER ()
C/C	CONNECTING CABLE
CCA	CONTROLLER CABLE "A"
CDP	C/C, DR POWER
CMA	MMU/CMU CABLE "A"
CMB	MMU/CMU CABLE "B"
CPO	C/C PRE-EMPT OUTPUTS
CPP	C/C PRE-EMPT POWER
DR	DETECTOR RACK
DS()	DOOR SWITCH ()
FL()	FLASHER ()
FR()	FLASH XFER. RELAY
LS()	LOAD SWITCH
MC	MERCURY CONTACTOR
MP	MAIN PANEL
PAP	POWER-AUX PANEL
PSP	CAB. PWR. SUPPLY
SA	SURGE ARRESTOR
TB-()	TERM. BLOCK ()

FLASHER	
PIN	FUNCTION
7	CIRCUIT #1
8	CIRCUIT #2
9	CHASSIS GND
10	AC COMMON
11	115 VAC
12	-----

LOAD SWITCH	
PIN	FUNCTION
1	115 VAC
2	CHASSIS GND
3	RED/DW OUTPUT
4	-----
5	YEL OUTPUT
6	RED/DW INPUT
7	GRN/W OUTPUT
8	YEL INPUT
9	+24 VDC
10	GRN/W INPUT
11	AC COMMON
12	-----

① 2.2K  
10W

3 USE ONLY COPPER CONDUCTORS FOR FIELD AND SERVICE CONNECTIONS.  
2 CONNECT A.C. SERVICE TO TERMINAL BLOCK 501 (LINE), 502 (NEUTRAL) AND GB2 (EARTH) ON RIGHT SIDEWALL OF CABINET.  
① INSTALL 2.2K, 10 WATT LOAD RESISTORS BETWEEN PINS 7 AND 11 ON LOAD SWITCHES 9, 10, 11 & 12.  
NOTES: UNLESS SPECIFIED OTHERWISE

MAIN PANEL PLUG-IN REQUIREMENTS

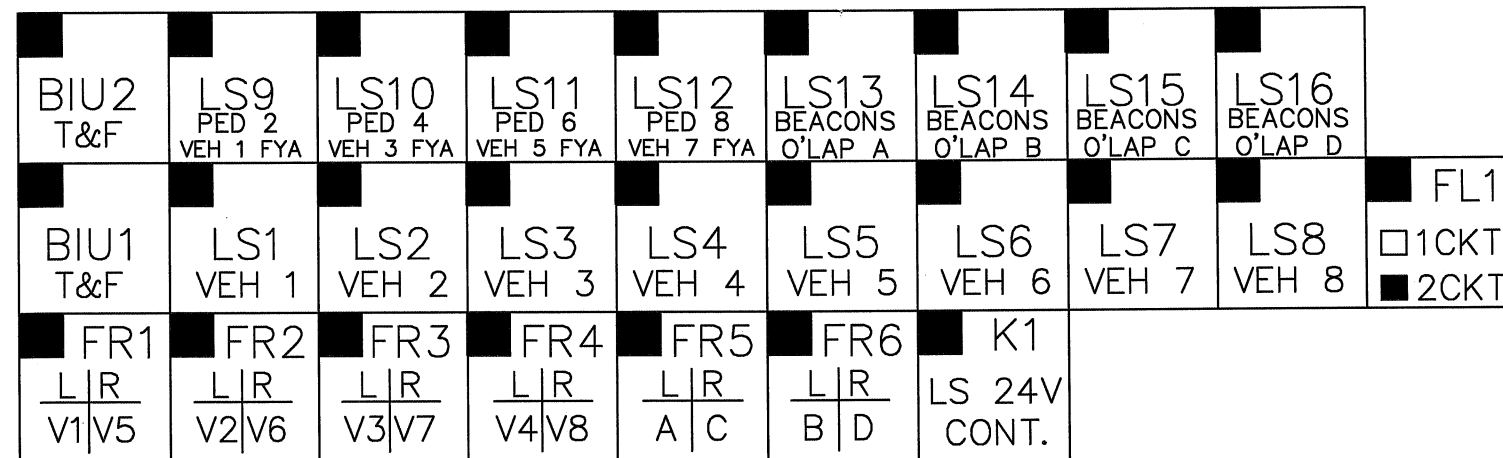

■ DENOTES TYPE OF OPERATION AND/OR WHERE PLUG-IN IS REQUIRED. L = LEFT, R = RIGHT.  
☒ DENOTES WHERE "UNUSED RED" JUMPER PART NUMBER 32448G1 IS REQUIRED. INSTALL BETWEEN PINS 1 & 3 FOR LOAD SWITCH OR PINS 6 & 8 AND 5 & 7 FOR FLASH TRANSFER RELAY.

FLASH:  
□ ø2&6 YELLOW, ALL OTHERS RED.  
■ ALL RED.  
■ RELAYS DE-ENERGIZED FOR FLASH.  
□ RELAYS ENERGIZED FOR FLASH.

120V+	950	TB2-12(BLK)
120V-	951	TB2-10(WHT)
120V-	952	
2W	953	-9G-A (RED-9C)
2DW	954	-9R-A (BLK-9C)
4W	955	-10G-A (BLU-9C)
4DW	956	-10R-A (BRN-9C)
6W	957	-11G-A (ORG-9C)
6DW	958	-11R-A (YEL-9C)
8W	959	-12G-A (PUR-9C)
8DW	960	-12R-A (WHT-9C)
SPARE	961	
SPARE	962	
GRND	963	TB2-9 (GRN)
GRND	964	
PC-2	965	-PC2-A (RED-4C)
PC-4	966	-PC4-A (BLK-4C)
PC-6	967	-PC6-A (GRN-4C)
PC-8	968	-PC8-A (WHT-4C)
SPARE	969	

PEDESTRIAN PUSHBUTTON/SIGNAL INTERFACE

JAY ST NW

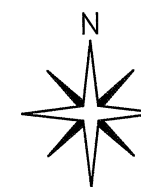

CSAH#116

SHEET 1 OF 7

DRAWN CM TCC	1/10/2024
CABINET SIZE	77"
INSPECTED	
APPROVED	
CUSTOMER P.O.	0008128

<p>ECONOLITE CONTROL PRODUCTS INC.</p>	<p>TRAFFIC CONTROL CORPORATION</p>	10435 ARGONNE WOODS DR. WOODRIDGE, IL 60517	
		CABINET SPECIFICATION: TS2TYPE1 ANOKA COUNTY SPEC PLUG AND GO	
CUSTOMER: ANOKA COUNTY		CONTROLLER	
INTERSECTION: CSAH#116 AT JAY ST NW		FLASHER	
LOCATION:		SW.PACKS	
SYSTEM:			
INSTALLED BY ANOKA COUNTY HIGHWAY DEPARTMENT		SALES ORDER NO. 737892	DRAWING # 655397-1



**CONFIRMATION BEACONS**

EVP 3 =1-6  
 EVP 4 =2-5  
 EVP 5 =3-8  
 EVP 6 =4-7

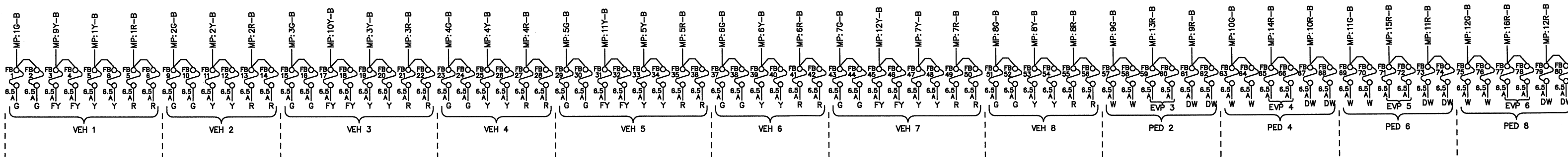
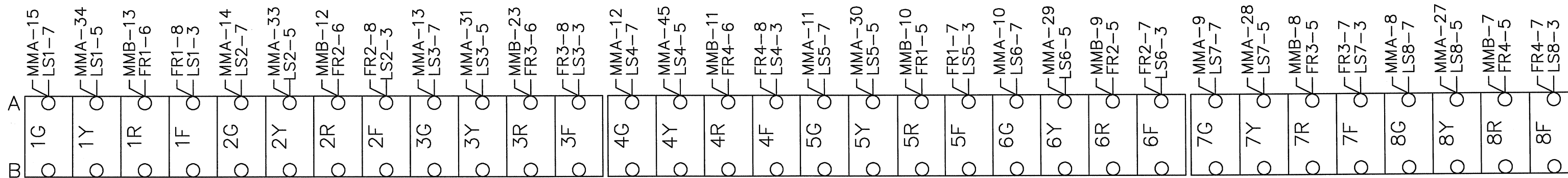
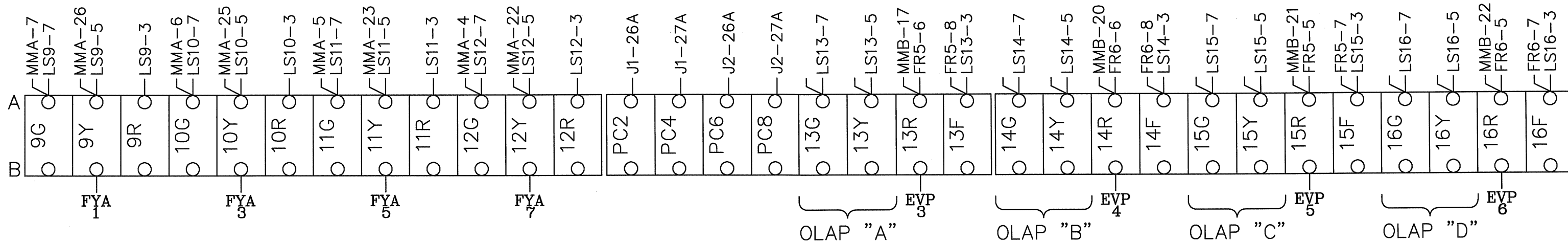

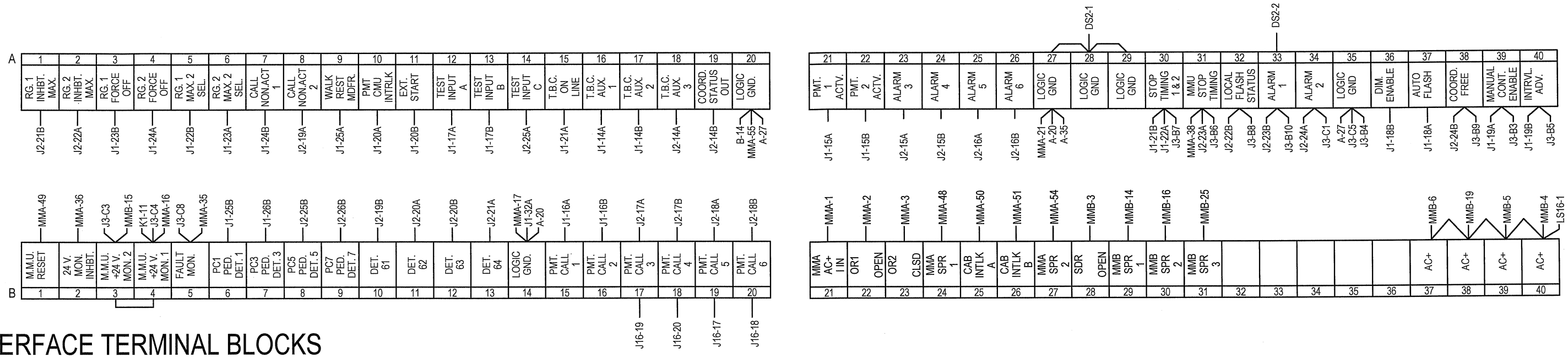

# INTERFACE TERMINAL BLOCKS

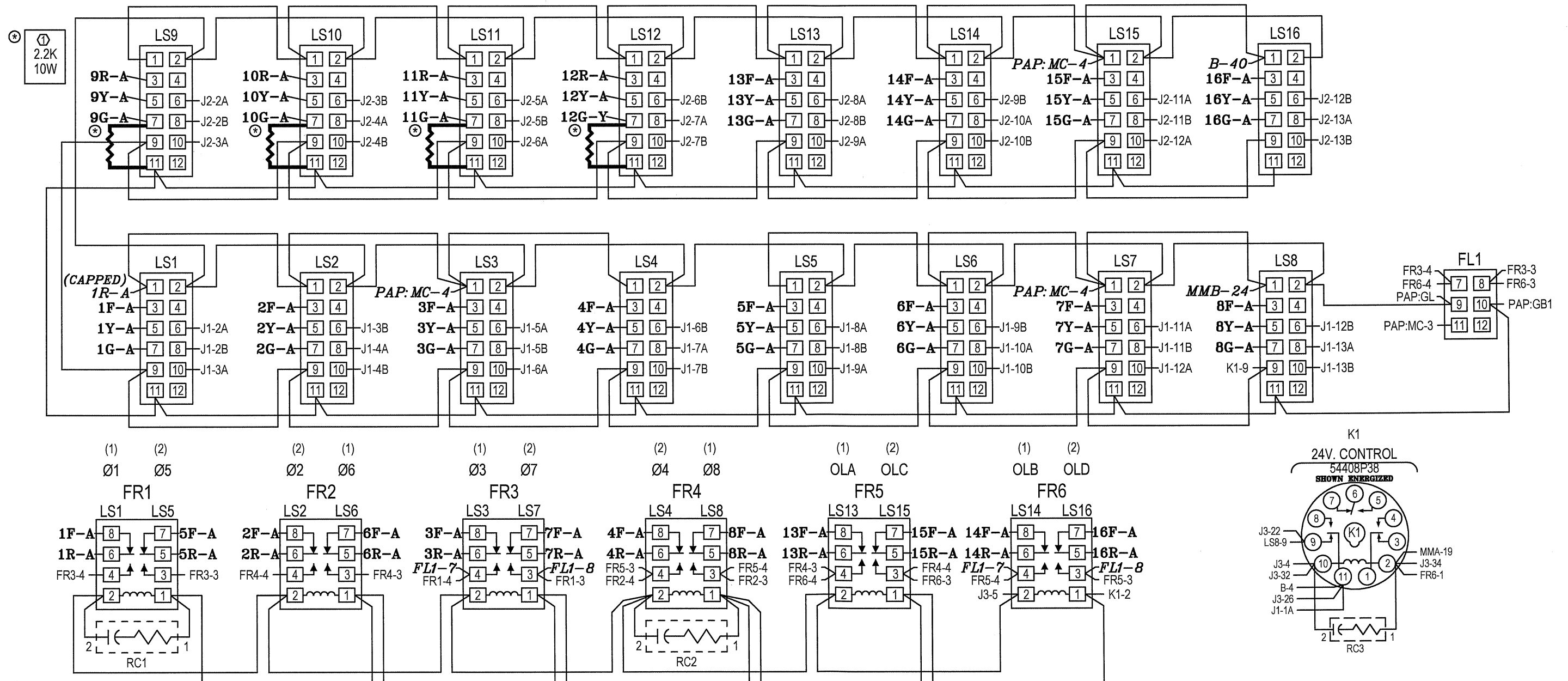

J1 BIU #1		
PIN	FUNCTION	TO
1A	+24 VDC	K1-11
1B	+24 VDC	J2-1B
2A	LS1 RED	LS1-6
2B	LS1 YELLOW	LS1-8
3A	LS1 GREEN	LS1-10
3B	LS2 RED	LS2-6
4A	LS2 YELLOW	LS2-8
4B	LS2 GREEN	LS2-10
5A	LS3 RED	LS3-6
5B	LS3 YELLOW	LS3-8
6A	LS3 GREEN	LS3-10
6B	LS4 RED	LS4-6
7A	LS4 YELLOW	LS4-8
7B	LS4 GREEN	LS4-10
8A	LS5 RED	LS5-6
8B	LS5 YELLOW	LS5-8
9A	LS5 GREEN	LS5-10
9B	LS6 RED	LS6-6
10A	LS6 YELLOW	LS6-8
10B	LS6 GREEN	LS6-10
11A	LS7 RED	LS7-6
11B	LS7 YELLOW	LS7-8
12A	LS7 GREEN	LS7-10
12B	LS8 RED	LS8-6
13A	LS8 YELLOW	LS8-8
13B	LS8 GREEN	LS8-10
14A	TBC AUX 1	A-16
14B	TBC AUX 2	A-17
15A	PMT ACT 1	A-21
15B	PMT ACT 2	A-22
16A	PMT CALL 1	B-15
16B	PMT CALL 2	B-16
17A	TEST A	A-12
17B	TEST B	A-13
18A	AUTO FLASH	A-37
18B	DIM. ENABLE	A-36
19A	MANUAL CONT.	A-39
19B	INT. ADVANCE	A-40
20A	EXT. MIN. RECALL	A-10
20B	EXT. START	A-11
21A	TBC ONLINE	A-15
21B	STOP TIME (1)	A-30
22A	STOP TIME (2)	A-30
22B	MAX. 2 (1)	A-5
23A	MAX. 2 (2)	A-6
23B	FORCE OFF (1)	A-3
24A	FORCE OFF (2)	A-4
24B	CNA 1	A-7
25A	WALK REST MOD.	A-9
25B	PED. ISO. 1	B-6
26A	PED. ISO. 2	PC2-A
26B	PED. ISO. 3	B-7
27A	PED. ISO. 4	PC4-A
27B	PED. ISO. COMN.	J3-D1
28A	ADDR. SEL. 0	---
28B	ADDR. SEL. 1	---
29A	ADDR. SEL. 2	---
29B	ADDR. SEL. 3	---
30A	RESERVED	---
30B	RESERVED	---
31A	EARTH GND.	LS12-2
31B	LINE FREQ. REF.	J3-C9
32A	LOGIC GND.	B-14
32B	LOGIC GND.	J2-32A

J2 BIU #2		
PIN	FUNCTION	TO
1A	+24 VDC	J2-1B
1B	+24 VDC	J1-1B
2A	LS9 RED	LS9-6
2B	LS9 YELLOW	LS9-8
3A	LS9 GREEN	LS9-10
3B	LS10 RED	LS10-6
4A	LS10 YELLOW	LS10-8
4B	LS10 GREEN	LS10-10
5A	LS11 RED	LS11-6
5B	LS11 YELLOW	LS11-8
6A	LS11 GREEN	LS11-10
6B	LS12 RED	LS12-6
7A	LS12 YELLOW	LS12-8
7B	LS12 GREEN	LS12-10
8A	LS13 RED	LS13-6
8B	LS13 YELLOW	LS13-8
9A	LS13 GREEN	LS13-10
9B	LS14 RED	LS14-6
10A	LS14 YELLOW	LS14-8
10B	LS14 GREEN	LS14-10
11A	LS15 RED	LS15-6
11B	LS15 YELLOW	LS15-8
12A	LS15 GREEN	LS15-10
12B	LS16-RED	LS16-6
13A	LS16-YELLOW	LS16-8
13B	LS16-GREEN	LS16-10
14A	TBC AUX 3	A-18
14B	COORD. STATUS	A-19
15A	ALARM 3	A-23
15B	ALARM 4	A-24
16A	ALARM 5	A-25
16B	ALARM 6	A-26
17A	PMT CALL 3	B-17
17B	PMT CALL 4	B-18
18A	PMT CALL 5	B-19
18B	PMT CALL 6	B-20
19A	CNA 2	A-8
19B	SPARE 1	B-10
20A	SPARE 2	B-11
20B	SPARE 3	B-12
21A	SPARE 4	B-13
21B	INHIBIT MAX (1)	A-1
22A	INHIBIT MAX (2)	A-2
22B	LOCAL FLASH	A-32
23A	MMU FLASH	A-31
23B	ALARM 1	A-33
24A	ALARM 2	A-34
24B	COORD FREE IN	A-38
25A	TEST C	A-14
25B	PED. ISO. 5	B-8
26A	PED. ISO. 6	PC6-A
26B	PED. ISO. 7	B-9
27A	PED. ISO. 8	PC8-A
27B	PED. ISO. COMN.	J1-27B
28A	ADDR. SEL. 0	J2-32A
28B	ADDR. SEL. 1	---
29A	ADDR. SEL. 2	---
29B	ADDR. SEL. 3	---
30A	RESERVED	---
30B	RESERVED	---
31A	EARTH GND.	J1-31A
31B	LINE FREQ. REF.	J1-31B
32A	LOGIC GND.	J1-32B
32B	LOGIC GND.	J2-32A

DETECTOR BIU		
PIN	FUNCTION	TO
1A	+24 VDC	---
1B	+24 VDC	---
2A	---	---
2B	---	---
3A	---	---
3B	---	---
4A	---	---
4B	---	---
5A	---	---
5B	---	---
6A	---	---
6B	---	---
7A	---	---
7B	---	---
8A	---	---
8B	---	---
9A	---	---
9B	---	---
10A	---	---
10B	---	---
11A	---	---
11B	---	---
12A	---	---
12B	---	---
13A	---	---
13B	---	---
14A	---	---
14B	---	---
15A	---	---
15B	---	---
16A	---	---
16B	---	---
17A	---	---
17B	---	---
18A	---	---
18B	---	---
19A	---	---
19B	---	---
20A	---	---
20B	---	---
21A	---	---
21B	---	---
22A	---	---
22B	---	---
23A	---	---
23B	---	---
24A	---	---
24B	---	---
25A	---	---
25B	---	---
26A	---	---
26B	---	---
27A	---	---
27B	---	---
28A	---	---
28B	---	---
29A	---	---
29B	---	---
30A	---	---
30B	---	---
31A	---	---
31B	---	---
32A	---	---
32B	---	---

MAIN PANEL CONTROL POWER C/C 171-1676-504	
PIN	FUNCTION
1	LOGIC GND
2	+24 VDC (IN)
3	---
4	MMU FAULT MONITOR (IN)
5	LINE FREQ. REFERENCE (IN)
6	---
7	+12 VAC (IN)
8	SIGNAL BUS CONTROL (IN)
9	---
10	FILTERED AC NEUTRAL (IN)
11	CONT. EQUIP. AC LINE (OUT)
12	FILTERED AC LINE (IN)
13	---
14	---

CONTROLLER POWER (CCA2) C/C 171-1676-503			
WIRE	PIN	SIGNAL	TO
1	A	FAULT MONITOR	PB-4
2	U	AC NEUTRAL	PB-10
3	V	EARTH GROUND	PB-9
4	W	LOGIC GROUND	PB-1
5	p	AC LINE	PB-11
6	SHL	EARTH GROUND	CCA2-V

TYPE 1 CONTROLLER POWER C/C 171-1676-502		
PIN	FUNCTION	TO
A	AC NEUTRAL	PB-10
B	---	---
C	AC LINE	PB-11
D	+12 VDC	---
E	+24 VDC	PB-2
F	RESERVED	---
G	FAULT MON.	PB-4
H	LOGIC GND.	PB-1
I	EARTH GND.	PB-9
J	---	---
SHL	EARTH GND.	PB-6

CABINET POWER SUPPLY C/C 171-1676-511		
PIN	FUNCTION	TO
A	AC NEUTRAL	PB-10
B	LINE FREQUENCY REF.	PB-5
C	AC LINE	PB-11
D	+12 VDC	---
E	+24 VDC	PB-2
F	RESERVED	---
G	LOGIC GND.	PB-1
H	EARTH GND.	PB-9
I	+12 VAC	PB-7
J	RESERVED	---
SHL	EARTH GND.	PIN H

CONTROLLER PORT 1 CONNECTOR			
PIN	SIGNAL	TO	FUNCTION
1	TWISTED PAIR 1+	SDLC-1	CONT TXD+
2	LOGIC GND.	---	---
3	TWISTED PAIR 2+	SDLC-4	CONT TXC+
4	LOGIC GND.	---	---
5	TWISTED PAIR 3+	SDLC-7	CONT RXD+
6	LOGIC GND.	---	---
7	TWISTED PAIR 4+	SDLC-10	CONT RXC+
8	LOGIC GND.	---	---
9	TWISTED PAIR 1-	SDLC-2	CONT TXD-
10	PORT 1 DISABLE	---	---
11	TWISTED PAIR 2-	SDLC-5	CONT TXC-
12	EARTH GND.	---	---
13	TWISTED PAIR 3-	SDLC-8	CONT RXD-
14	RESERVED	---	---
15	TWISTED PAIR 4-	SDLC-11	CONT RXC-

MMU & BIU PORT 1 CONNECTOR			
PIN	SIGNAL	TO	FUNCTION
1	TWISTED PAIR 1+	SDLC-1	BIU RXD+
2	LOGIC GND.	---	---
3	TWISTED PAIR 2+	SDLC-4	BIU RXC+
4	LOGIC GND.	---	---
5	TWISTED PAIR 3+	SDLC-7	BIU TXD+
6	LOGIC GND.	---	---
7	TWISTED PAIR 4+	SDLC-10	BIU TXC+
8	LOGIC GND.	---	---
9	TWISTED PAIR 1-	SDLC-2	BIU RXD-
10	PORT 1 DISABLE	---	---
11	TWISTED PAIR 2-	SDLC-5	BIU RXC-
12	EARTH GND.	---	---
13	TWISTED PAIR 3-	SDLC-8	BIU TXD-
14	RESERVED	---	---
15	TWISTED PAIR 4-	SDLC-11	BIU TXC-

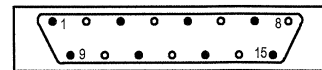

FRONT VIEW OF BU1 - BU5

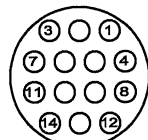

FRONT VIEW OF J1-J6

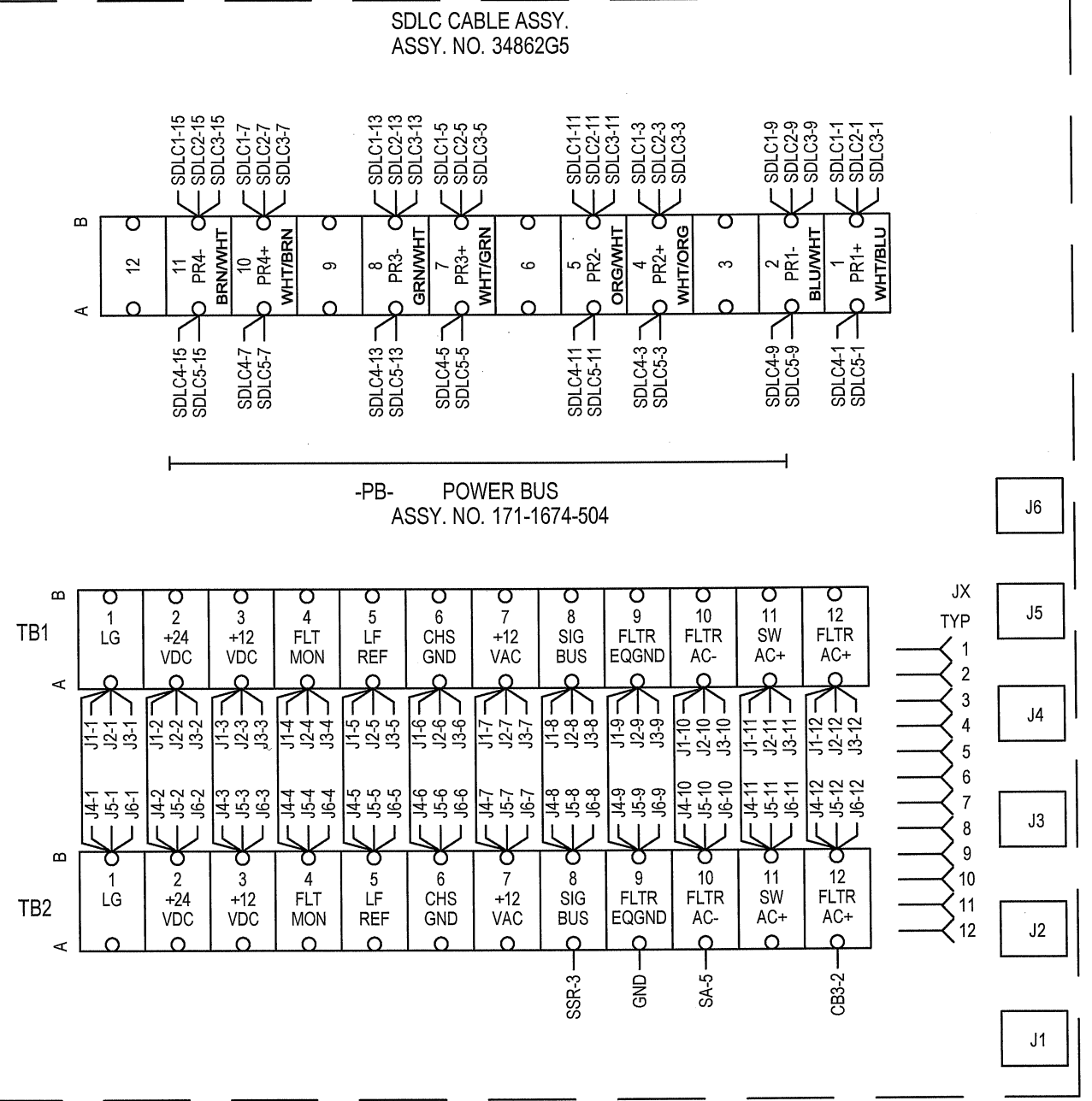

BIU AND CONNECTING CABLES

## WIRE LIST FOR NEMA MALFUNCTION MANAGEMENT UNIT

CONNECTOR "A" (MMA)					CONNECTOR "B" (MMB)				
PIN	WIRE	MON. FUNCTION	TO	SIG. FUNCTION	PIN	WIRE	MON. FUNCTION	TO	SIG. FUNCTION
A	A-1	AC+ I INPUT	B21		A	B-1	AC+ II INPUT	J3-A2	MMU POWER
B	A-2	OUT RLY 1 OPEN	B22		B	B-2	S. DLY RLY COMM.	J3-A6	MMU POWER
C	A-3	OUT RLY 2 CLSD	B23		C	B-3	S. DLY RLY OPEN	B28	
D	A-4	CH. 12 GREEN	12G-A	^8 WLK	D	B-4	CH. 12 RED	B40	
E	A-5	CH. 11 GREEN	11G-A	^6 WLK	E	B-5	CH. 11 RED	B39	
F	A-6	CH. 10 GREEN	10G-A	^4 WLK	F	B-6	CH. 9 RED	B37	
G	A-7	CH. 9 GREEN	9G-A	^2 WLK	G	B-7	CH. 8 RED	8R-A	^8 RED
H	A-8	CH. 8 GREEN	8G-A	^8 GRN	H	B-8	CH. 7 RED	7R-A	^7 RED
J	A-9	CH. 7 GREEN	7G-A	^7 GRN	J	B-9	CH. 6 RED	6R-A	^6 RED
K	A-10	CH. 6 GREEN	6G-A	^6 GRN	K	B-10	CH. 5 RED	5R-A	^5 RED
L	A-11	CH. 5 GREEN	5G-A	^5 GRN	L	B-11	CH. 4 RED	4R-A	^4 RED
M	A-12	CH. 4 GREEN	4G-A	^4 GRN	M	B-12	CH. 2 RED	2R-A	^2 RED
N	A-13	CH. 3 GREEN	3G-A	^3 GRN	N	B-13	CH. 1 RED	1R-A	^1 RED
P	A-14	CH. 2 GREEN	2G-A	^2 GRN	P	B-14	(SPARE 1)	B29	
R	A-15	CH. 1 GREEN	1G-A	^1 GRN	R	B-15	+24V MONITOR II	B-3	+24V MON. II
S	A-16	+24V MON. I	B-4	LS +24V MON.	S	B-16	(SPARE 2)	B30	
T	A-17	LOGIC GND	B-14	LOGIC GND	T	B-17	CH. 13 RED	13R-A	OLA RED
U	A-18	CHASSIS GND	LS7-2	EARTH GND.	U	B-18	S. DLY RLY CLSD	J3-D5	CONT. POWER
V	A-19	AC- (COMMON)	K1-2	AC NEUTRAL	V	B-19	CH. 10 RED	B38	
W	A-20	OUT RLY 1 COM.	J3-A7	SIG BUS CONT	W	B-20	CH. 14 RED	14R-A	OLB RED
X	A-21	OUT RLY 2 COM.	A-27	LOGIC GND	X	B-21	CH. 15 RED	15R-A	OLC RED
Y	A-22	CH. 12 YELLOW	12Y-A	-T-	Y	B-22	CH. 16 RED	16R-A	OLD RED
Z	A-23	CH. 11 YELLOW	11Y-A	-T-	Z	B-23	CH. 3 RED	3R-A	^3 RED
a	A-24	CH. 10 WALK	----		a	B-24	RED ENABLE	LS8-1	SIG BUS CON.
b	A-25	CH. 10 YELLOW	10Y-A	-T-	b	B-25	(SPARE 3)	B31	
c	A-26	CH. 9 YELLOW	9Y-A	-T-	c	B-26	LOCAL FLASH IN	A32	POL/AX FLSH
d	A-27	CH. 8 YELLOW	8Y-A	^8 YEL		B-27	SHELL GROUND	LS6-2	EARTH GND.
e	A-28	CH. 7 YELLOW	7Y-A	^7 YEL	<b>NOTES FOR 16 CHANNEL M.M.U.</b> (1) RELAY CONTACT POSITIONS SPECIFIED ARE FOR NON-CONFLICT MODE. (2) TO PROGRAM MMU, SOLDER JUMPERS IN PROGRAMMING CARD FOR ALL PERMISSABLE PHASE MOVEMENTS, MINIMUM CHANGE DISABLE FOR ALL PEDESTRIAN CHANNELS, AND MIN. FLASH, VOLTAGE MON., AND 24V. MON. LATCH OPTIONS AS DESIRED.  <b>M.M.U. CHANNEL ASSIGNMENTS</b> CH. 1 = L/S 1 = ^1 VEH. CH. 2 = L/S 2 = ^2 VEH. CH. 3 = L/S 3 = ^3 VEH. CH. 4 = L/S 4 = ^4 VEH. CH. 5 = L/S 5 = ^5 VEH. CH. 6 = L/S 6 = ^6 VEH. CH. 7 = L/S 7 = ^7 VEH. CH. 8 = L/S 8 = ^8 VEH. CH. 9 = L/S 9 = ^2 PED. CH. 10 = L/S 10 = ^4 PED. CH. 11 = L/S 11 = ^6 PED. CH. 12 = L/S 12 = ^8 PED. CH. 13 = L/S 13 = O'LAP A VEH. CH. 14 = L/S 14 = O'LAP B VEH. CH. 15 = L/S 15 = O'LAP C VEH. CH. 16 = L/S 16 = O'LAP D VEH.				
f	A-29	CH. 6 YELLOW	6Y-A	^6 YEL					
g	A-30	CH. 5 YELLOW	5Y-A	^5 YEL					
h	A-31	CH. 3 YELLOW	3Y-A	^3 YEL					
i	A-32	CH. 15 YELLOW	15G-A	OLC YEL					
j	A-33	CH. 2 YELLOW	2Y-A	^2 YEL					
k	A-34	CH. 1 YELLOW	1Y-A	^1 YEL					
m	A-35	CONT. VOLT. MON.	B-5	VOLT. MON.					
n	A-36	+24V MON. INH.	B-2						
p	A-37	OUT RLY 1 CLSD	J3-A3						
q	A-38	OUT RLY 2 OPEN	A-31	STOP TIME					
r	A-39	CH. 12 WALK	----						
s	A-40	CH. 11 WALK	----						
t	A-41	CH. 9 WALK	----						
u	A-42	CH. 16 YELLOW	16Y-A	OLD YEL					
v	A-43	CH. 15 YELLOW	15Y-A	OLA YEL					
w	A-44	CH. 13 YELLOW	13Y-A	OLA YEL					
x	A-45	CH. 4 YELLOW	4Y-A	^4 YEL					
y	A-46	CH. 14 GREEN	14G-A	OLB GRN					
z	A-47	CH. 13 GREEN	13G-A	OLA GRN					
AA	A-48	(SPARE 1)	B24						
BB	A-49	RESET	B-1						
CC	A-50	CAB. INTLK A	B25						
DD	A-51	CAB. INTLK B	B26						
EE	A-52	CH. 14 YELLOW	14Y-A	OLB YEL					
FF	A-53	CH. 16 GREEN	16G-A	OLD GRN					
GG	A-54	(SPARE 2)	B27						
HH	A-55	TYPE SELECT	A-20	MMU/CMU SEL.					
	A-56	SHELL GND	LS15-2	EARTH GND.					

## MMU PROGRAM CARD

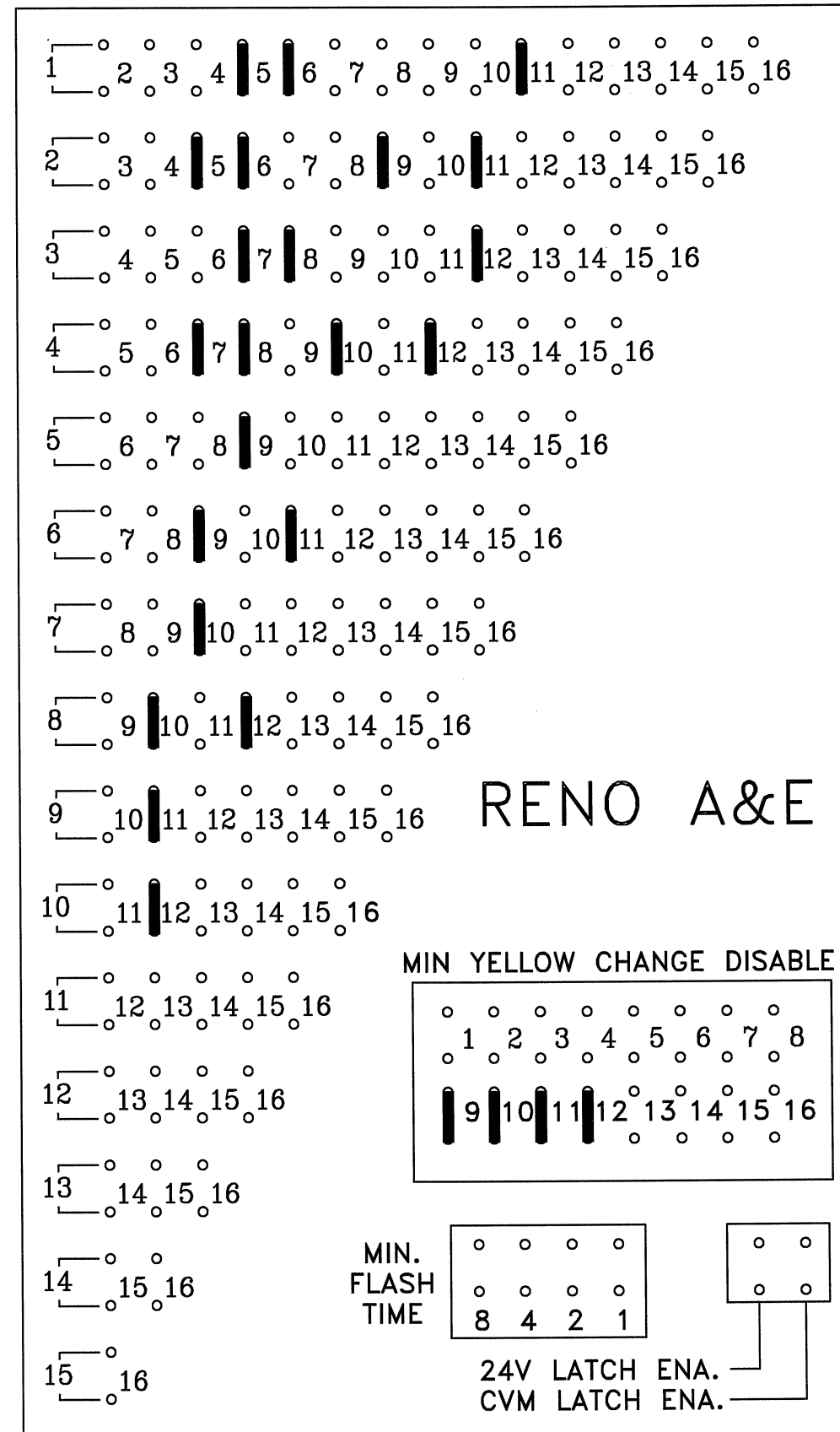

RENO A&E

## M.M.U. C/C'S AND PROGRAM CARD

DETECTOR RACK 34030G1 #1

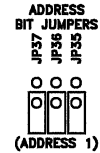
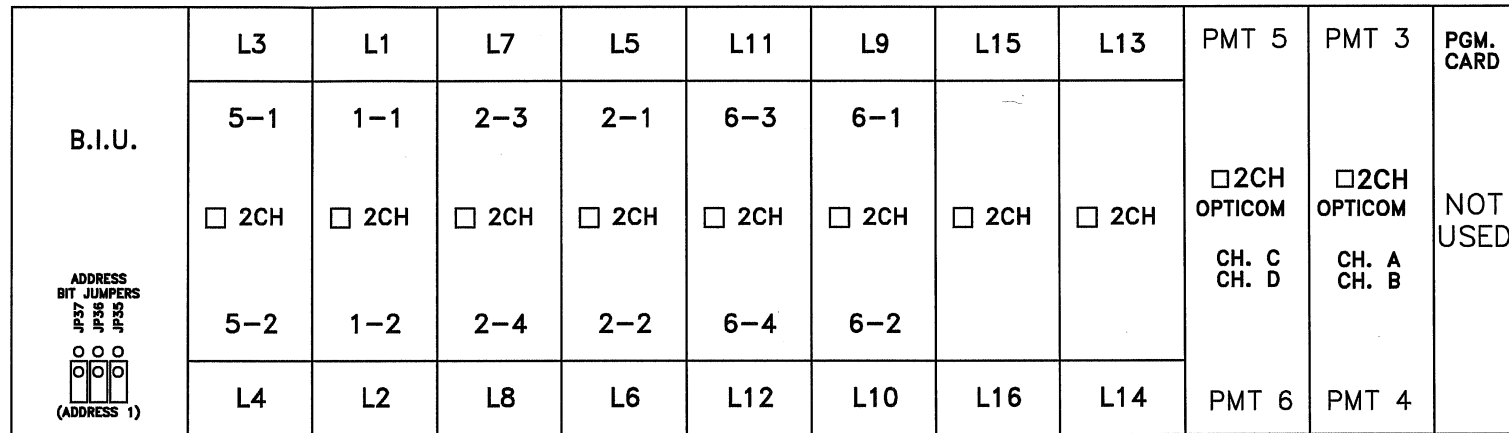

<input checked="" type="checkbox"/> J13 171-1083-515 DC POWER	<input checked="" type="checkbox"/> J16 C/C 33284G8 EXP. OUTPUTS	<input checked="" type="checkbox"/> J14 C/C 33284G2 LPS 1-8	<input type="checkbox"/> J18 C/C 33284G9 SYS. OUTPUTS	<input checked="" type="checkbox"/> J15 C/C 33284G3 LPS 9-16	<input checked="" type="checkbox"/> J17 171-1083-515 AC POWER	<input type="checkbox"/> J19 C/C 33284G17 PGM. CARD
---	--	---	---	--	---	---

DETECTOR RACK 34030G1 #2

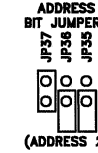
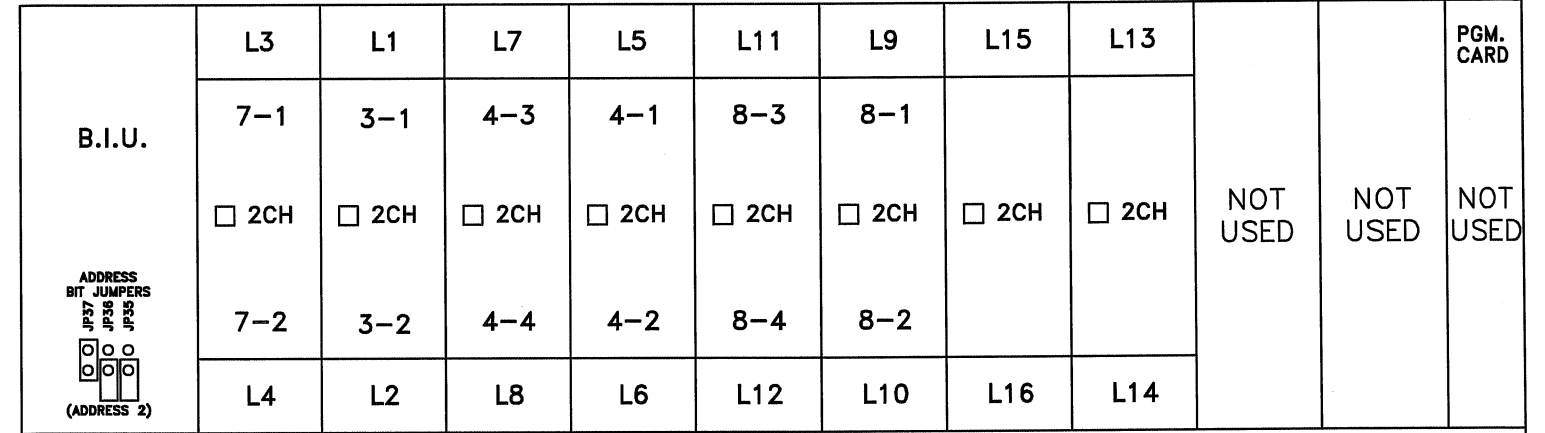

<input checked="" type="checkbox"/> J13 171-1083-515 DC POWER	<input type="checkbox"/> J16 C/C 33284G8 EXP. OUTPUTS	<input checked="" type="checkbox"/> J14 C/C 33284G2 LPS 1-8	<input type="checkbox"/> J18 C/C 33284G9 SYS. OUTPUTS	<input checked="" type="checkbox"/> J15 C/C 33284G3 LPS 9-16	<input checked="" type="checkbox"/> J17 171-1083-515 AC POWER	<input type="checkbox"/> J19 C/C 33284G17 PGM. CARD
---	---	---	---	--	---	---

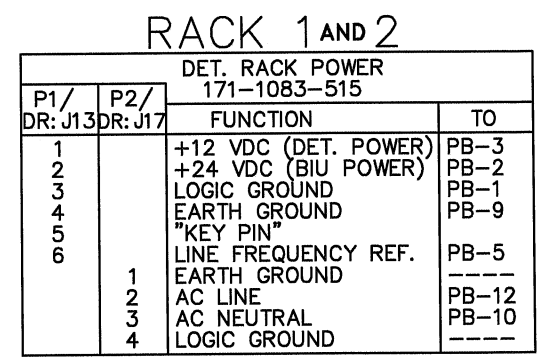
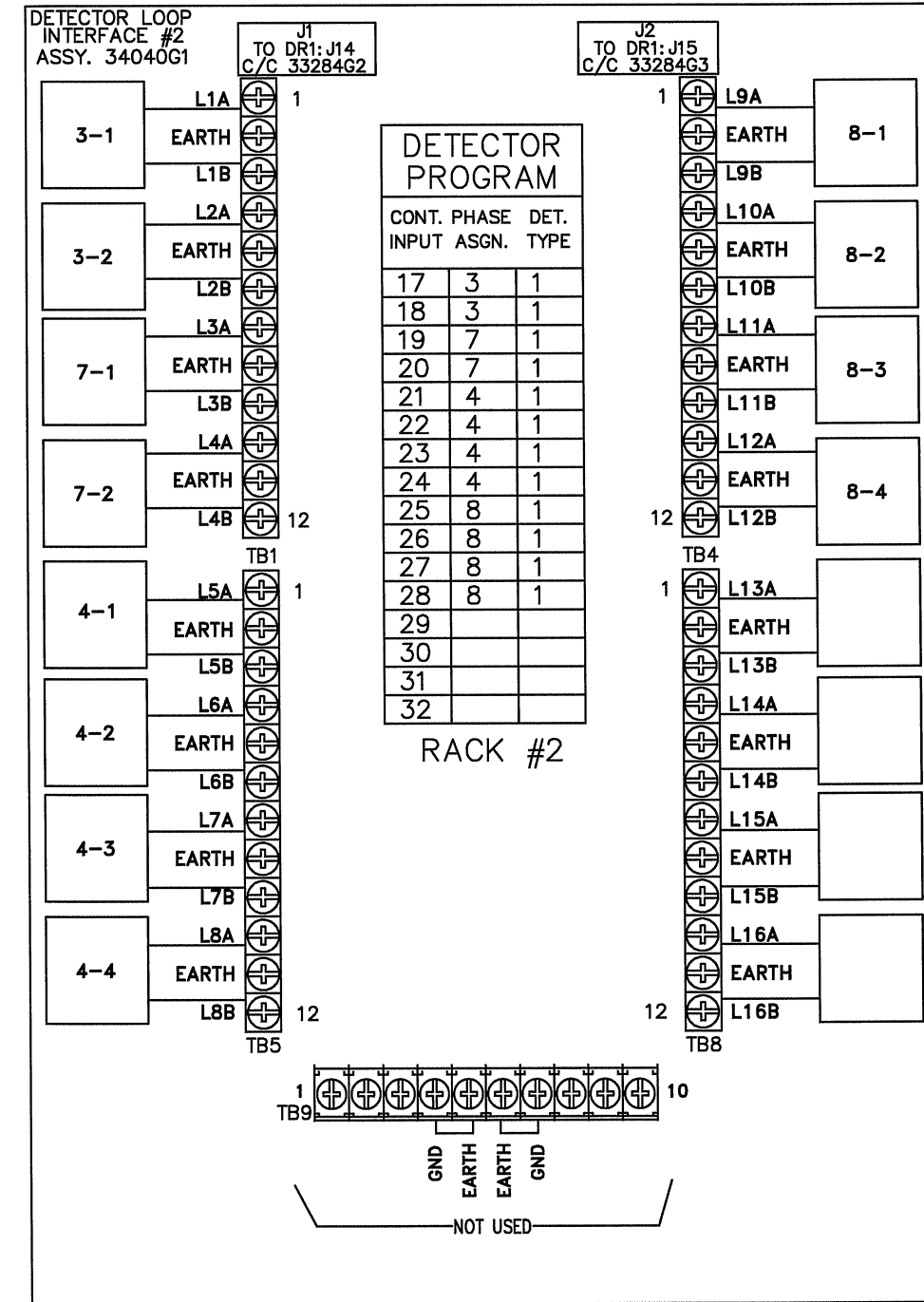
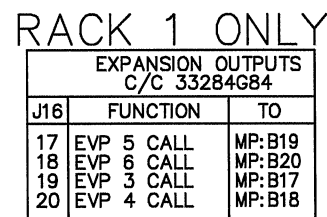
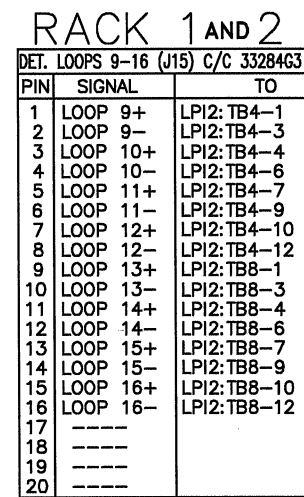
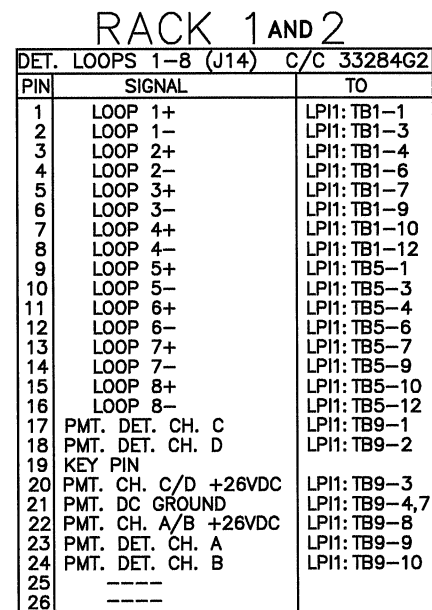
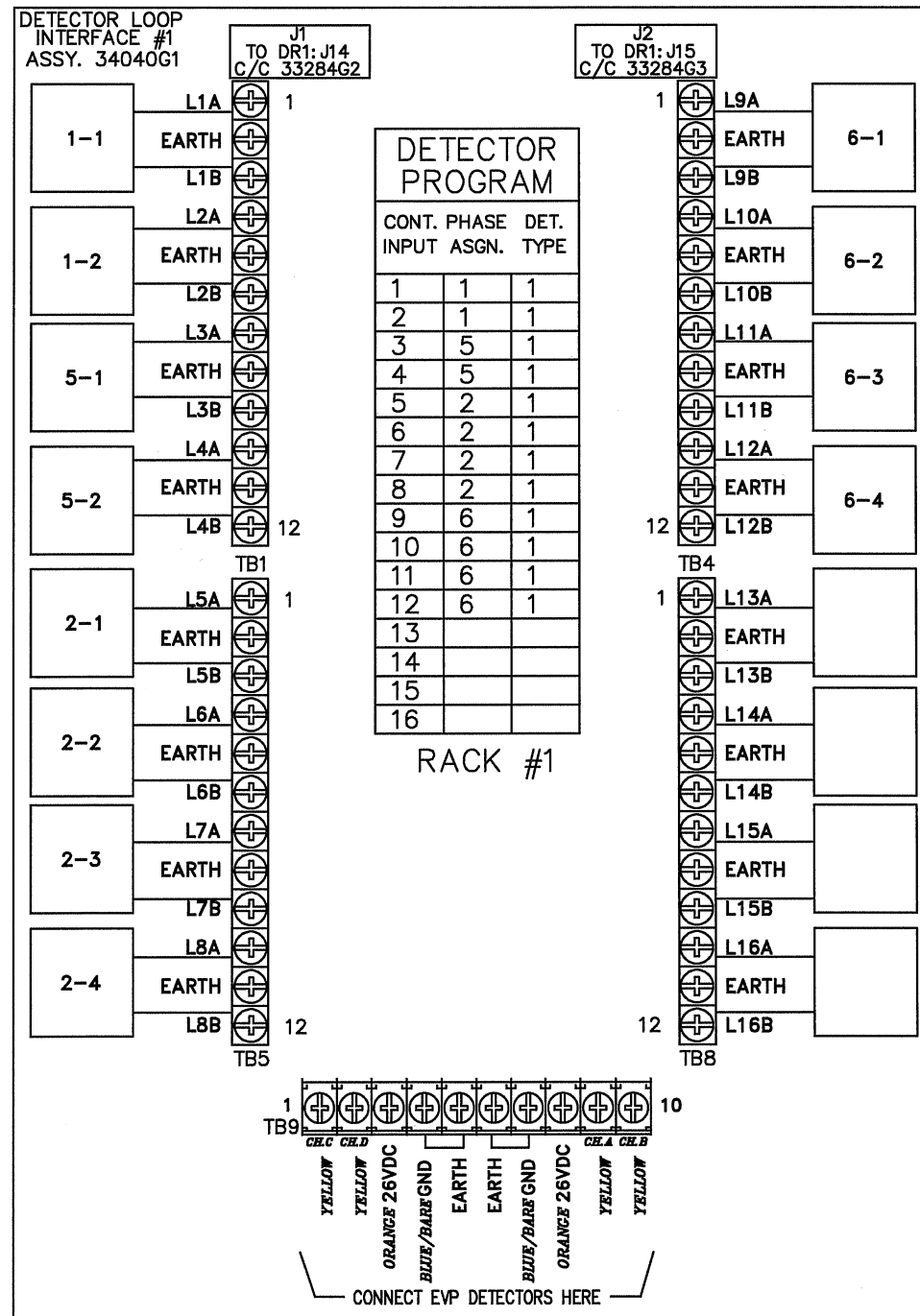

<b>B.I.U</b>	DET	PH	F	DET	DLY	EXT	DET	PH	F	DET	DLY	EXT	DET	PH	F	DET	DLY	EXT	DET	PH	F	DET	DLY	EXT	EVP	PH	POLE #	CONT CH #
	CH 1	1	1	1-1			CH 5	2	1	2-1			CH 9	6	1	6-1			CH 13						CH 1	1-6	4	3
	CH 2	1	1	1-2			CH 6	2	1	2-2			CH 10	6	1	6-2			CH 14						CH 2	2-5	2	4
	CH 3	5	1	5-1			CH 7	2	1	2-3			CH 11	6	1	6-3			CH 15						CH 3	3-8	1	5
	CH 4	5	1	5-2			CH 8	2	1	2-4			CH 12	6	1	6-4			CH 16						CH 4	4-7	3	6
<b>B.I.U</b>	DET	PH	F	DET	DLY	EXT	DET	PH	F	DET	DLY	EXT	DET	PH	F	DET	DLY	EXT	DET	PH	F	DET	DLY	EXT				
	CH 17	3	1	3-1			CH 21	4	1	4-1			CH 25	8	1	8-1			CH 29									
	CH 18	3	7	3-2			CH 22	4	1	4-2			CH 26	8	1	8-2			CH 30									
	CH 19	7	1	7-1			CH 23	4	1	4-3	10.0		CH 27	8	1	8-3	10.0		CH 31									
	CH 20	7	7	7-2			CH 24	4	1	4-4			CH 28	8	1	8-4			CH 32									

**EVP SENSORS**

CABLE	DISCR. CHAN.	PHASES	POLE#	TERMINAL TB9		
				SIGNAL	DC(+)	GND
56	1	1-6	4	A	26+	GND
28	2	2-5	2	B	26+	GND
18	3	3-8	1	C	26+	GND
65	4	4-7	3	D	26+	GND

**EVP VERIFY LIGHTS**

CABLE	CONTR. CHAN.	PHASES	POLE#	TERM.
27	4	2-5	2	65
17	5	3-8	1	71
64	6	4-7	3	77

**VEHICLE SIGNALS**

CABLE	SIGNAL	TERMINAL						
		G ←	FLA	Y ←	R ←	G	Y	R
47	1-1	1	3	5	7			
57	1-2	2	4	6	8			
22,24	2-1,2-3					9	11	13
23	2-2					10	12	14
10	3-1	15	17	19	21			
48	3-2	16	18	20	22			
60	4-1					23	25	27
61	4-2					24	26	28
19	5-1	29	31	33	35			
11	5-2	30	32	34	36			
50,52	6-1,6-3					37	39	41
51	6-2					38	40	42
58	7-1	43	45	47	49			
20	7-2	44	46	48	50			
13	8-1					51	53	55
14	8-2					52	54	56

**VEH DETECTORS**

CABLE	DET	SLOT	FUNC	RACK	TERMINAL
37	1-1	1	1	1	L1
38	1-2	2	1	1	L2
81	2-1	5	1	1	L5
82	2-2	6	1	1	L6
80	2-3	7	1	1	L7
79	2-4	8	1	1	L8
43	3-1	17	1	1	L1
44	3-2	18	1	1	L2
76	4-1	21	1	2	L5
73	4-2	22	1	2	L6
74	4-3	23	7	2	L7
75	4-4	24	1	2	L8
77	5-1	3	1	1	L3
78	5-2	4	1	1	L4
35	6-1	9	1	1	L9
36	6-2	10	1	1	L10
34	6-3	11	1	1	L11
39	6-4	12	1	1	L12
71	7-1	19	1	2	L3
72	7-2	20	1	2	L4
45	8-1	25	1	2	L9
46	8-2	26	1	2	L10
41	8-3	27	7	2	L11
42	8-4	28	1	2	L12

**PED PUSHBUTTONS**

CABLE	PPB	TERMINAL	RETURN
70	2-1	1	2
33	2-2	1	2
68	4-1	1	2
69	4-2	1	2
30	6-1	1	2
67	6-2	1	2
32	8-1	1	2
31	8-2	1	2

**PED SIGNALS**

CABLE	SIGNAL	TERMINAL	
		WK	DW
62	2-1	57	61
26	2-2	58	62
53	4-1	63	67
63	4-2	64	68
15	6-1	69	73
54	6-2	70	74
25	8-1	75	79
16	8-2	76	80