

ASC/2S-2100 CONTROLLER WITH:

- CONFIGURATION EEPROM 32790C1440
- SOFTWARE: V1.72
- SPECIAL SOFTWARE: SEE BELOW FUNCTION
- OVERLAPS
 - IN EEPROM
 - KEYBOARD ENTERED
- ANALOG TELEMETRY MODULE: 32825G1
- F/O TELEMETRY MODULE: 33525G1
- TEST INPUT A =
- TEST INPUT B =

A =
B =
C =
D =

LEGEND

BIU	BUS INTERFACE UNIT
BU()	C/C, BIU ()
CB()	CIRCUIT BREAKER ()
C/C	CONNECTING CABLE
CCA	CONTROLLER CABLE "A"
CDP	C/C, DR POWER
CMA	MMU/CMU CABLE "A"
CMB	MMU/CMU CABLE "B"
CPO	C/C PRE-EMPT OUTPUTS
CPP	C/C PRE-EMPT POWER
DR	DETECTOR RACK
DS()	DOOR SWITCH ()
FL()	FLASHER ()
FR()	FLASH XFER. RELAY
LS()	LOAD SWITCH
MC	MERCURY CONTACTOR
MP	MAIN PANEL
PAP	POWER-AUX PANEL
PSP	CAB. PWR. SUPPLY
SA	SURGE ARRESTOR
TB-()	TERM. BLOCK ()

MAIN PANEL PLUG-IN REQUIREMENTS

BIU2 T&F	BIU3 T&F	LS9 PED 2 BEACONS	LS10 PED 4 BEACONS	LS11 PED 6 BEACONS	LS12 PED 8 BEACONS	LS13 OL "A"	LS14 OL "B"	LS15 OL "C"	LS16 OL "D"
BIU1 T&F	LS1 VEH 1	LS2 VEH 2	LS3 VEH 3	LS4 VEH 4	LS5 VEH 5	LS6 VEH 6	LS7 VEH 7	LS8 VEH 8	FL1 □ 1CKT ■ 2CKT
FR1	FR2	FR3	FR4	✗ FR5	✗ FR6	K1			
L R V1 V5	L R V2 V6	L R V3 V7	L R V4 V8	L R A C	L R B D	LS 24V CONT.			

■ DENOTES TYPE OF OPERATION AND/OR WHERE PLUG-IN IS REQUIRED. L = LEFT, R = RIGHT.
 ✗ DENOTES WHERE "UNUSED RED" JUMPER PART NUMBER 32448G1 IS REQUIRED. INSTALL BETWEEN PINS 1 & 3 FOR LOAD SWITCH OR PINS 6 & 8 AND 5 & 7 FOR FLASH TRANSFER RELAY.

FLASH:
 □ ø2&6 YELLOW, ALL OTHERS RED.
 ■ ALL RED.
 ■ RELAYS DE-ENERGIZED FOR FLASH.
 □ RELAYS ENERGIZED FOR FLASH.

FLASHER	
PIN	FUNCTION
7	CIRCUIT #1
8	CIRCUIT #2
9	CHASSIS GND
10	AC COMMON
11	115 VAC
12	-----

LOAD SWITCH	
PIN	FUNCTION
1	115 VAC
2	CHASSIS GND
3	RED/DW OUTPUT
4	-----
5	YEL OUTPUT
6	RED/DW INPUT
7	GRN/W OUTPUT
8	YEL INPUT
9	+24 VDC
10	GRN/W INPUT
11	AC COMMON
12	-----

①
2.2K
10W

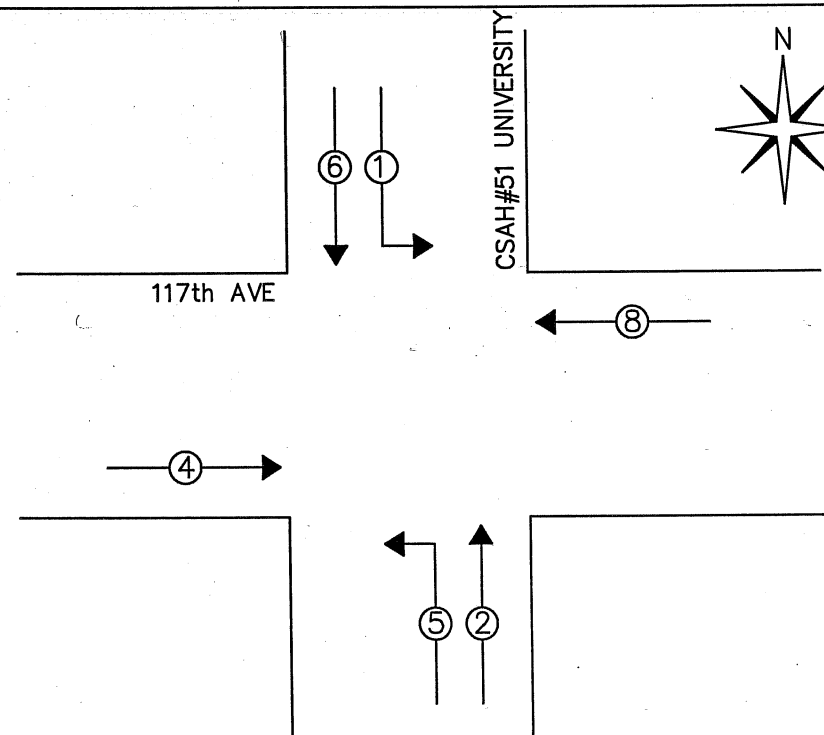



SHEET 1 OF 11

3 USE ONLY COPPER CONDUCTORS FOR FIELD AND SERVICE CONNECTIONS.

2 CONNECT A.C. SERVICE TO TERMINAL BLOCK 501 (LINE), 502 (NEUTRAL) AND GB2 (EARTH) ON RIGHT SIDEWALL OF CABINET.

① INSTALL 2.2K, 10 WATT LOAD RESISTORS BETWEEN PINS 7 AND 11 ON LOAD SWITCHES 9, 10, 11 & 12.

NOTES: UNLESS SPECIFIED OTHERWISE

DESIGNER G.V. T.C.C.	DATE 02/03/97	 ECONOLITE CONTROL PRODUCTS INC.	 TRAFFIC CONTROL CORPORATION	5653 MEMORIAL AVE. OAK PARK HTS, MN 55082
DRAWN MA TCC	6/9/04			CABINET SPECIFICATION: TS2TYPE1 2004 ANOKA COUNTY
CABINET SIZE		CUSTOMER: ANOKA COUNTY HIGHWAY DEPARTMENT		CONTROLLER
INSPECTED		INTERSECTION: CSAH#51 AT 117TH		FLASHER
APPROVED		LOCATION:		SW.PACKS
CUSTOMER P.O.	INSTALLED BY	SALES ORDER NO.	SIZE B	DRAWING #TS20216PG INTERC

AUXILLARY SWITCH PANEL

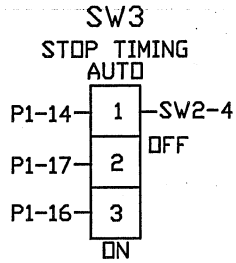
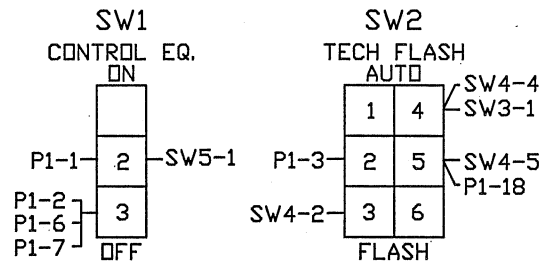

POLICE SWITCH PANEL

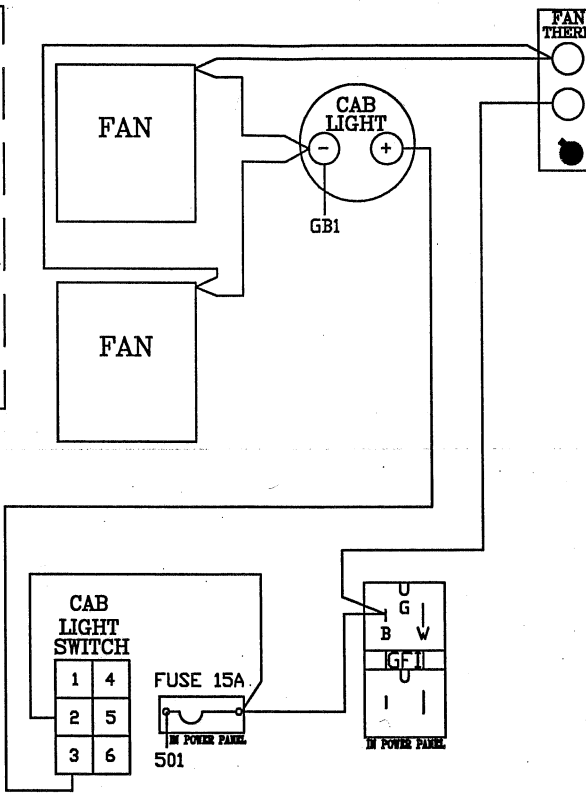
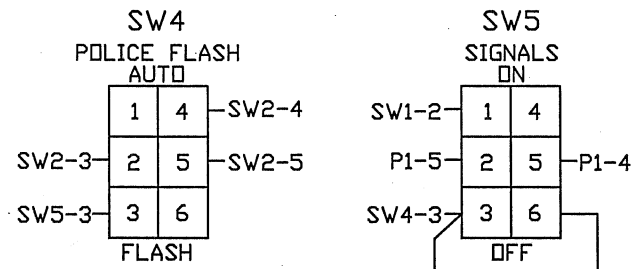

POWER/AUX PANEL (PAP) 34830G5

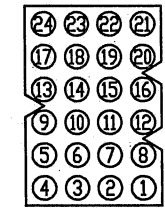
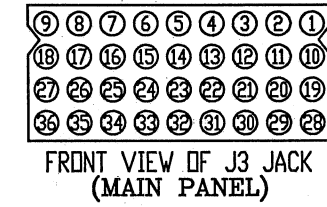
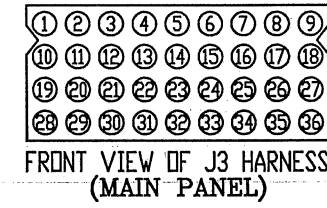
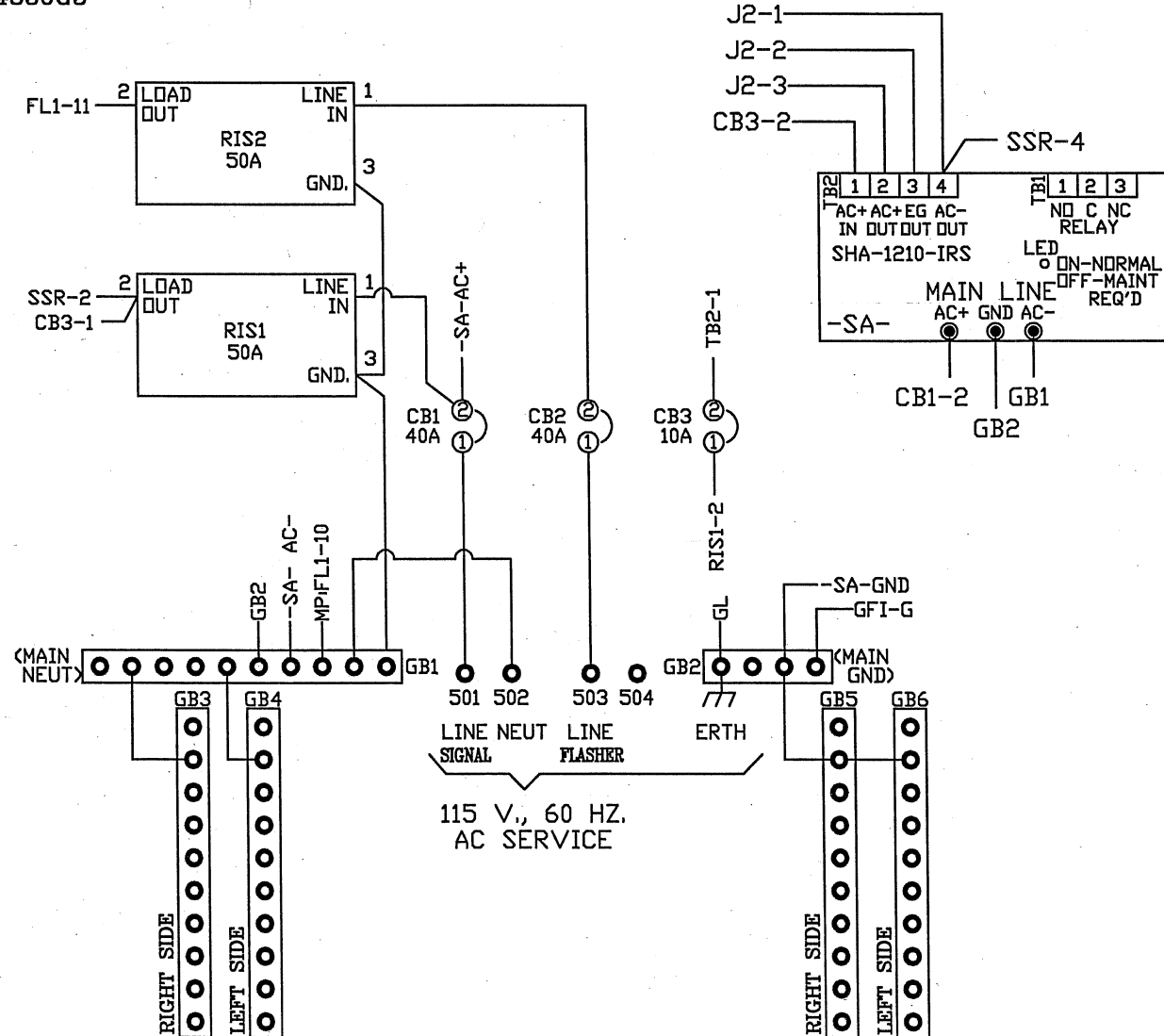
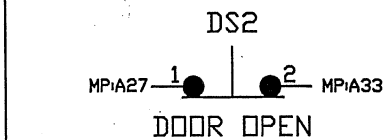
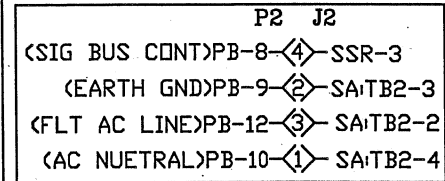
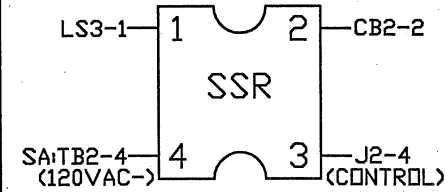

FRONT VIEW OF J1 HARNESS (SWITCH PANEL)

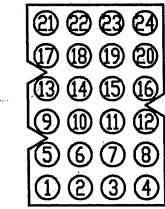

FRONT VIEW OF J1 JACK (SWITCH PANEL)

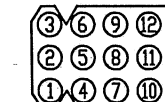

FRONT VIEW OF J1-J6 HARNESSES (POWER BUS PANEL)

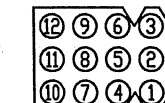

FRONT VIEW OF J1-J6 JACKS (POWER BUS PANEL)

J3		P1	
J3-36	1	1	SW1-2
MMB-1	2	2	SW1-3
MMA-37	3	3	SW2-3
K1-10	4	4	SW5-5
FR6-2	5	5	SW5-2
MMB-2	6	6	SW1-3
MMA-20	7	7	SW1-3
	8	8	---
	9	9	---
	10	10	---
	11	11	---
	12	12	---
A-39	13	13	---
A-35	14	14	SW3-1
A-40	15	15	---
A-31	16	16	SW3-3
A-30	17	17	SW3-2
A-32	18	18	SW2-5
A-38	19	19	---
A-33	20	20	---
A-34	21	21	---
K1-9	22	22	---
B-3	23	23	---
B-4	24	24	---

J3		J1	
A-35	25	1	TB1-1
K1-11	26	2	TB1-2
	27	---	TB1-3
B-5	28	4	TB1-4
J1-31B	29	5	TB1-5
	30	---	TB1-6
J1-27B	31	7	TB1-7
K1-10	32	8	TB1-8
	33	---	TB1-9
K1-2	34	10	TB1-10
MMB-18	35	11	TB1-11
J3-1	36	12	TB1-12

①
2.2K
10W

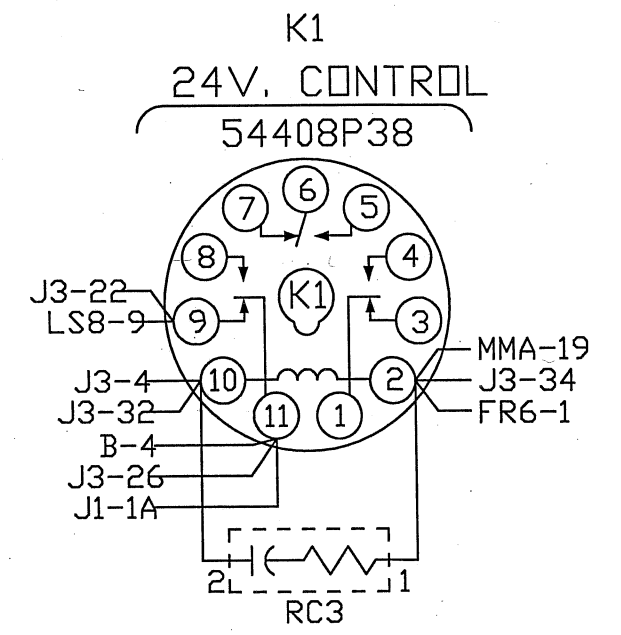
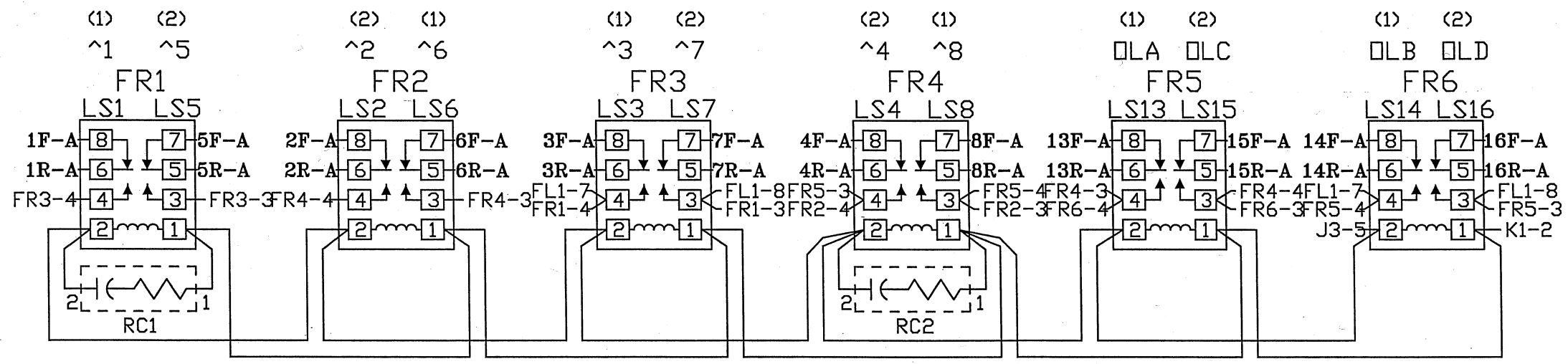
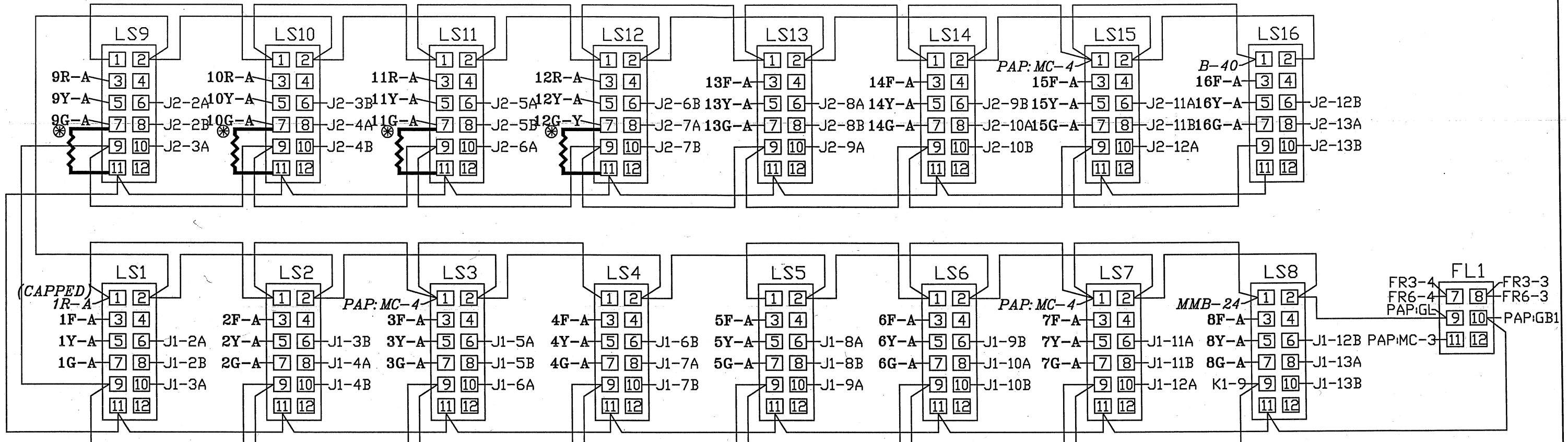

LOADBAY AND FLASH RELAY'S

B	1	M.M.U. RESET	MMA-49	J2-21B	RG. 1 INHBT. MAX.
	2	24 V. MON. INHBT.	MMA-36	J2-22A	RG. 2 INHBT. MAX.
	3	M.M.U. +24 V. MON. 2	J3-23	J1-23B	RG. 1 FORCE OFF
	4	M.M.U. +24 V. MON. 1	MMB-15	K1-11	RG. 2 FORCE OFF
	5	FAULT MON.	J3-24	J1-24A	RG. 1 MAX. 2 SEL.
	6	PCI PED. DET. 1	MMA-35	J1-22B	RG. 2 MAX. 2 SEL.
	7	PC3 PED. DET. 3	J1-25B	J1-23A	CALL NON-AC 1
	8	PC5 PED. DET. 5	J1-26B	J1-24B	CALL NON-AC 2
	9	PC7 PED. DET. 7	J2-25B	J2-19A	WALK REST MDFR.
	10	B.I.U. SPR. 1	J2-26B	J1-25A	EXT. MIN. RECALL
	11	B.I.U. SPR. 2	J2-19B	J1-20A	EXT. START
	12	B.I.U. SPR. 3	J2-20A	J1-20B	TEST INPUT A
	13	B.I.U. SPR. 4	J2-20B	J1-17A	TEST INPUT B
	14	LOGIC GND.	J2-21A	J1-17B	TEST INPUT C
	15	PMT. CALL 1	MMA-17	J1-32A	T.B.C. ON LINE
	16	PMT. CALL 2	J1-16A	J1-21A	T.B.C. AUX. 1
	17	PMT. CALL 3	J1-16B	J1-14A	T.B.C. AUX. 2
	18	PMT. CALL 4	J2-17A	J1-14B	T.B.C. AUX. 3
	19	PMT. CALL 5	J2-17B	J2-14A	COORD. STATUS OUT
	20	PMT. CALL 6	J2-18A	J2-14B	LOGIC GND.

J16-19
J16-20
J16-17
J16-18

	21	MMA AC+ I IN	MMA-1	J1-15A	PMT. 1 ACTV.
	22	OR1 OPEN	MMA-2	J1-15B	PMT. 2 ACTV.
	23	OR2 OPEN	MMA-3	J2-15A	PMT. 3 ACTV.
	24	CLSD	MMA-48	J2-15B	PMT. 4 ACTV.
	25	MMA SPR 1	MMA-50	J2-16A	PMT. 5 ACTV.
	26	CAB INTLK A	MMA-51	J2-16B	PMT. 6 ACTV.
	27	MMA SPR 2	MMA-21	MMA-54	LOGIC GND
	28	SDR OPEN	MMA-54	A-20	LOGIC GND
	29	MMB SPR 1	MMB-3	A-35	LOGIC GND
	30	MMB SPR 2	MMB-14		LOGIC GND
	31	MMB SPR 3	J1-21B	J1-22A	STOP TIMING 1 & 2
	32		J3-17	J3-17	MMU STOP TIMING
	33		MMA-38	J2-22B	LOCAL FLASH STATUS
	34		MMA-25	J3-18	ALARM 1
	35		J2-23B	J2-23B	ALARM 2
	36		J3-20	J3-20	LOGIC GND
	37	AC+	J2-24A	J3-21	DIM. ENABLE
	38	AC+	J3-21	A-27	AUTO FLASH
	39	AC+	J3-25	J3-14	COORD. FREE
	40	AC+	J3-14	J1-18B	MANUAL CONT. ENABLE

BIU #1			BIU #2		
PIN	FUNCTION	TO	PIN	FUNCTION	TO
1A	+24 VDC	K1-11	1A	+24 VDC	J2-1B
1B	+24 VDC	J2-1B	1B	+24 VDC	J1-1B
2A	LS1 RED	LS1-6	2A	LS9 RED	LS9-6
2B	LS1 YELLOW	LS1-8	2B	LS9 YELLOW	LS9-8
3A	LS1 GREEN	LS1-10	3A	LS9 GREEN	LS9-10
3B	LS2 RED	LS2-6	3B	LS10 RED	LS10-6
4A	LS2 YELLOW	LS2-8	4A	LS10 YELLOW	LS10-8
4B	LS2 GREEN	LS2-10	4B	LS10 GREEN	LS10-10
5A	LS3 RED	LS3-6	5A	LS11 RED	LS11-6
5B	LS3 YELLOW	LS3-8	5B	LS11 YELLOW	LS11-8
6A	LS3 GREEN	LS3-10	6A	LS11 GREEN	LS11-10
6B	LS4 RED	LS4-6	6B	LS12 RED	LS12-6
7A	LS4 YELLOW	LS4-8	7A	LS12 YELLOW	LS12-8
7B	LS4 GREEN	LS4-10	7B	LS12 GREEN	LS12-10
8A	LS5 RED	LS5-6	8A	LS13 RED	LS13-6
8B	LS5 YELLOW	LS5-8	8B	LS13 YELLOW	LS13-8
9A	LS5 GREEN	LS5-10	9A	LS13 GREEN	LS13-10
9B	LS6 RED	LS6-6	9B	LS14 RED	LS14-6
10A	LS6 YELLOW	LS6-8	10A	LS14 YELLOW	LS14-8
10B	LS6 GREEN	LS6-10	10B	LS14 GREEN	LS14-10
11A	LS7 RED	LS7-6	11A	LS15 RED	LS15-6
11B	LS7 YELLOW	LS7-8	11B	LS15 YELLOW	LS15-8
12A	LS7 GREEN	LS7-10	12A	LS15 GREEN	LS15-10
12B	LS8 RED	LS8-6	12B	LS16 RED	LS16-6
13A	LS8 YELLOW	LS8-8	13A	LS16 YELLOW	LS16-8
13B	LS8 GREEN	LS8-10	13B	LS16 GREEN	LS16-10
14A	TBC AUX 1	A-16	14A	TBC AUX 3	A-18
14B	TBC AUX 2	A-17	14B	COORD. STATUS	A-19
15A	PMT ACT 1	A-21	15A	PMT ACT 3	A-23
15B	PMT ACT 2	A-22	15B	PMT ACT 4	A-24
16A	PMT CALL 1	B-15	16A	PMT ACT 5	A-25
16B	PMT CALL 2	B-16	16B	PMT ACT 6	A-26
17A	TEST A	A-12	17A	PMT CALL 3	B-17
17B	TEST B	A-13	17B	PMT CALL 4	B-18
18A	AUTO FLASH	A-37	18A	PMT CALL 5	B-19
18B	DIM. ENABLE	A-36	18B	PMT CALL 6	B-20
19A	MANUAL CONT.	A-39	19A	CNA 2	A-8
19B	INT. ADVANCE	A-40	19B	SPARE 1	B-10
20A	EXT. MIN. RECALL	A-10	20A	SPARE 2	B-11
20B	EXT. START	A-11	20B	SPARE 3	B-12
21A	TBC ONLINE	A-15	21A	SPARE 4	B-13
21B	STOP TIME (1)	A-30	21B	INHIBIT MAX (1)	A-1
22A	STOP TIME (2)	A-30	22A	INHIBIT MAX (2)	A-2
22B	MAX. 2 (1)	A-5	22B	LOCAL FLASH	A-32
23A	MAX. 2 (2)	A-6	23A	MMU FLASH	A-31
23B	FORCE OFF (1)	A-3	23B	ALARM 1	A-33
24A	FORCE OFF (2)	A-4	24A	ALARM 2	A-34
24B	CNA 1	A-7	24B	COORD FREE IN	A-38
25A	WALK REST MOD.	A-9	25A	TEST C	A-14
25B	PED. ISD. 1	B-6	25B	PED. ISD. 5	B-8
26A	PED. ISD. 2	PC2-A	26A	PED. ISD. 6	PC6-A
26B	PED. ISD. 3	B-7	26B	PED. ISD. 7	B-9
27A	PED. ISD. 4	PC4-A	27A	PED. ISD. 8	PC8-A
27B	PED. ISD. COMN.	J3-31	27B	PED. ISD. COMN.	J1-27B
28A	ADDR. SEL. 0	-----	28A	ADDR. SEL. 0	J2-32A
28B	ADDR. SEL. 1	-----	28B	ADDR. SEL. 1	-----
29A	ADDR. SEL. 2	-----	29A	ADDR. SEL. 2	-----
29B	ADDR. SEL. 3	-----	29B	ADDR. SEL. 3	-----
30A	RESERVED	-----	30A	RESERVED	-----
30B	RESERVED	-----	30B	RESERVED	-----
31A	EARTH GND.	LS12-2	31A	EARTH GND.	J1-31A
31B	LINE FREQ. REF.	J3-29	31B	LINE FREQ. REF.	J1-31B
32A	LOGIC GND.	B-14	32A	LOGIC GND.	J1-32B
32B	LOGIC GND.	J2-32A	32B	LOGIC GND.	J2-32A

MAIN PANEL CONTROL POWER C/C 34842G4	
PIN	FUNCTION
1	LOGIC GROUND
2	+24 VDC (IN)
3	-----
4	MMU FAULT MONITOR (IN)
5	LINE FREQ. REFERENCE (IN)
6	-----
7	+12 VAC (IN)
8	SIGNAL BUS CONTROL (IN)
9	-----
10	FILTERED AC NEUTRAL (IN)
11	CONT. EQUIP. AC LINE (OUT)
12	FILTERED AC LINE (IN)

CONTROLLER POWER (CCA2) C/C 34842G3			
WIRE	PIN	SIGNAL	TO
1	A	FAULT MONITOR	PB-4
2	U	AC NEUTRAL	PB-10
3	V	EARTH GROUND	PB-9
4	W	LOGIC GROUND	PB-1
5	P	AC LINE	PB-11
6	SHL	EARTH GROUND	CCA2-V

TYPE 1 CONTROLLER POWER C/C 34842G2		
PIN	FUNCTION	TO
A	AC NEUTRAL	PB-10
B	-----	-----
C	AC LINE	PB-11
D	-----	-----
E	-----	-----
F	-----	-----
G	FAULT MON.	PB-4
H	LOGIC GND.	PB-1
I	EARTH GND.	PB-9
J	-----	-----
SHL	EARTH GND.	PIN H

CABINET POWER SUPPLY C/C 34842G1		
PIN	FUNCTION	TO
A	AC NEUTRAL	PB-10
B	LINE FREQUENCY REF.	PB-5
C	AC LINE	PB-11
D	+12 VDC	PB-3
E	+24 VDC	PB-2
F	RESERVED	-----
G	LOGIC GND.	PB-1
H	EARTH GND.	PB-9
I	+12 VAC	PB-7
J	RESERVED	-----
SHL	EARTH GND.	PIN H

CONTROLLER PORT 1 CONNECTOR			
PIN	SIGNAL	TO	FUNCTION
1	TWISTED PAIR 1+	SDLC-1	CONT TXD+
2	LOGIC GND.	-----	-----
3	TWISTED PAIR 2+	SDLC-4	CONT TXC+
4	LOGIC GND.	-----	-----
5	TWISTED PAIR 3+	SDLC-7	CONT RXD+
6	LOGIC GND.	-----	-----
7	TWISTED PAIR 4+	SDLC-10	CONT RXC+
8	LOGIC GND.	-----	-----
9	TWISTED PAIR 1-	SDLC-2	CONT TXD-
10	PORT 1 DISABLE	-----	-----
11	TWISTED PAIR 2-	SDLC-5	CONT TXC-
12	EARTH GND.	SHIELD WIRE	-----
13	TWISTED PAIR 3-	SDLC-8	CONT RXD-
14	RESERVED	-----	-----
15	TWISTED PAIR 4-	SDLC-11	CONT RXC-

MMU & BIU PORT 1 CONNECTOR			
PIN	SIGNAL	TO	FUNCTION
1	TWISTED PAIR 1+	SDLC-1	BIU RXD+
2	LOGIC GND.	-----	-----
3	TWISTED PAIR 2+	SDLC-4	BIU RXC+
4	LOGIC GND.	-----	-----
5	TWISTED PAIR 3+	SDLC-7	BIU TXD+
6	LOGIC GND.	-----	-----
7	TWISTED PAIR 4+	SDLC-10	BIU TXC+
8	LOGIC GND.	-----	-----
9	TWISTED PAIR 1-	SDLC-2	BIU RXD-
10	PORT 1 DISABLE	-----	-----
11	TWISTED PAIR 2-	SDLC-5	BIU RXC-
12	EARTH GND.	SHIELD WIRE	BIU TXD-
13	TWISTED PAIR 3-	SDLC-8	-----
14	RESERVED	-----	-----
15	TWISTED PAIR 4-	SDLC-11	BIU TXC-

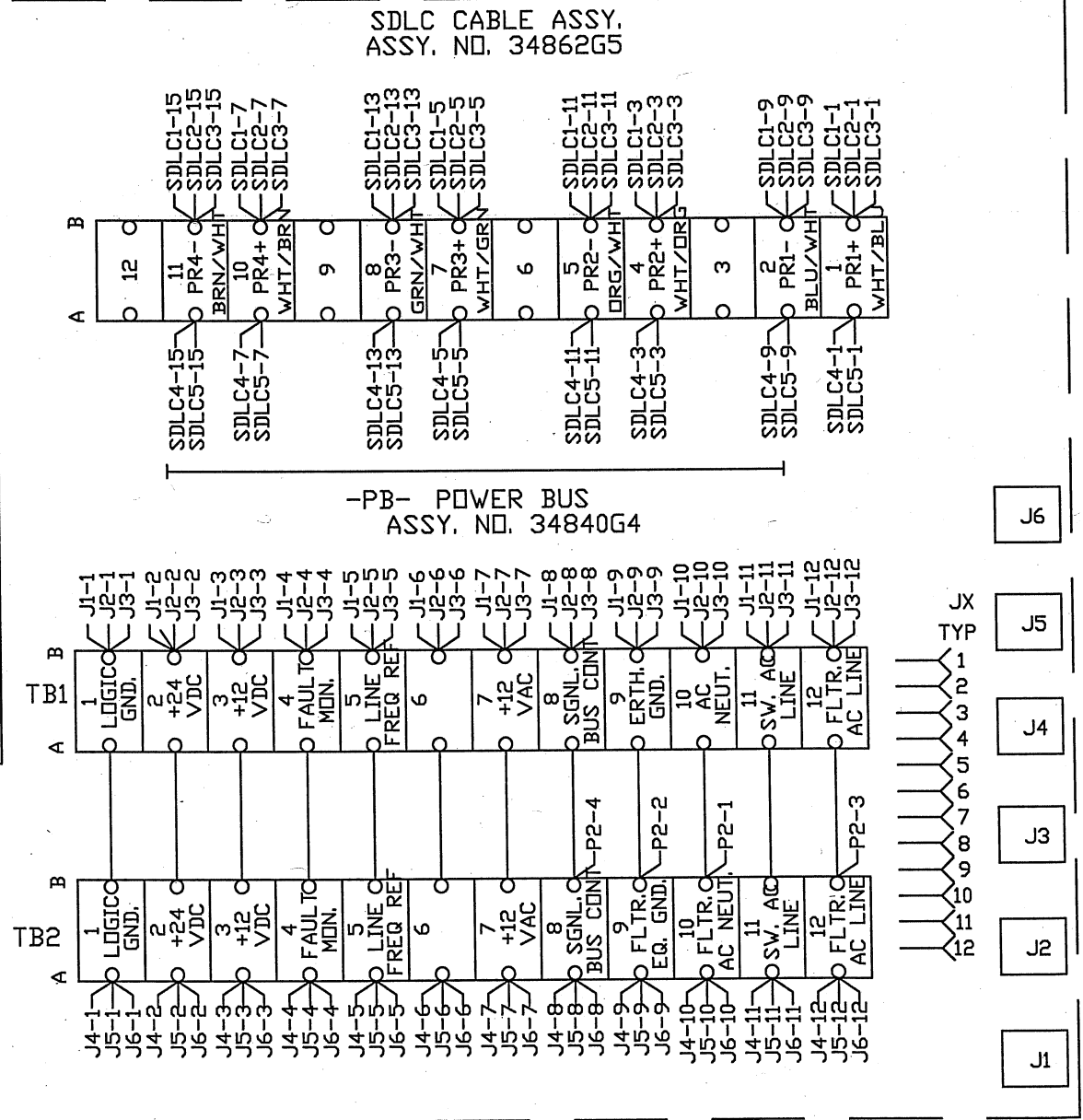
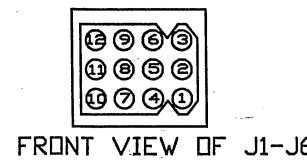
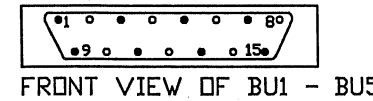

BIU AND CONNECTING CABLES

WIRE LIST FOR NEMA MALFUNCTION MANAGEMENT UNIT

CONNECTOR "A" (MMA)				CONNECTOR "B" (MMB)			
PIN	WIRE	MON. FUNCTION	TO SIG. FUNCTION	PIN	WIRE	MON. FUNCTION	TO SIG. FUNCTION
A	A-1	AC+ I INPUT	B21	A	B-1	AC+ II INPUT	J3-2 MMU POWER
B	A-2	OUT RLY 1 OPEN	B22	B	B-2	S. DLY RLY COMM.	J3-6 MMU POWER
C	A-3	OUT RLY 2 CLSD	B23	C	B-3	S. DLY RLY OPEN	B28
D	A-4	CH. 12 GREEN	12G-A ^8 WLK	D	B-4	CH. 12 RED	B40
E	A-5	CH. 11 GREEN	11G-A ^6 WLK	E	B-5	CH. 11 RED	B39
F	A-6	CH. 10 GREEN	10G-A ^4 WLK	F	B-6	CH. 9 RED	B37
G	A-7	CH. 9 GREEN	9G-A ^2 WLK	G	B-7	CH. 8 RED	8R-A ^8 RED
H	A-8	CH. 8 GREEN	8G-A ^8 GRN	H	B-8	CH. 7 RED	7R-A ^7 RED
J	A-9	CH. 7 GREEN	7G-A ^7 GRN	J	B-9	CH. 6 RED	6R-A ^6 RED
K	A-10	CH. 6 GREEN	6G-A ^6 GRN	K	B-10	CH. 5 RED	5R-A ^5 RED
L	A-11	CH. 5 GREEN	5G-A ^5 GRN	L	B-11	CH. 4 RED	4R-A ^4 RED
M	A-12	CH. 4 GREEN	4G-A ^4 GRN	M	B-12	CH. 2 RED	2R-A ^2 RED
N	A-13	CH. 3 GREEN	3G-A ^3 GRN	N	B-13	CH. 1 RED	1R-A ^1 RED
P	A-14	CH. 2 GREEN	2G-A ^2 GRN	P	B-14	(SPARE 1)	B29
R	A-15	CH. 1 GREEN	1G-A ^1 GRN	R	B-15	+24V MONITOR II	B-3 +24V MON. II
S	A-16	+24V MON. I	B-4 LS +24V MON.	S	B-16	(SPARE 2)	B30
T	A-17	LOGIC GND	B-14 LOGIC GND	T	B-17	CH. 13 RED	13R-A OLA RED
U	A-18	CHASSIS GND	LS7-2 EARTH GND.	U	B-18	S. DLY RLY CLSD	J3-35 CONT. POWER
V	A-19	AC- (COMMON)	K1-2 AC NEUTRAL	V	B-19	CH. 10 RED	B38
W	A-20	OUT RLY 1 COM.	J3-7 SIG BUS CONT	W	B-20	CH. 14 RED	14R-A OLB RED
X	A-21	OUT RLY 2 COM.	A-27 LOGIC GND	X	B-21	CH. 15 RED	15R-A OLC RED
Y	A-22	CH. 12 YELLOW	-T-	Y	B-22	CH. 16 RED	16R-A OLD RED
Z	A-23	CH. 11 YELLOW	-T-	Z	B-23	CH. 3 RED	3R-A ^3 RED
a	A-24	CH. 10 WALK	----	a	B-24	RED ENABLE	LS8-1 SIG BUS CON.
b	A-25	CH. 10 YELLOW	-T-	b	B-25	(SPARE 3)	B31
c	A-26	CH. 9 YELLOW	-T-	c	B-26	LOCAL FLASH IN	CAPPED POL/AX FLSH
d	A-27	CH. 8 YELLOW	8Y-A ^8 YEL		B-27	SHELL GROUND	LS6-2 EARTH GND.
e	A-28	CH. 7 YELLOW	7Y-A ^7 YEL	NOTES FOR 16 CHANNEL M.M.U.			
f	A-29	CH. 6 YELLOW	6Y-A ^6 YEL	(1) RELAY CONTACT POSITIONS SPECIFIED ARE FOR NON-CONFLICT MODE.			
g	A-30	CH. 5 YELLOW	5Y-A ^5 YEL	(2) TO PROGRAM MMU, SOLDER JUMPERS IN PROGRAMMING CARD FOR ALL PERMISSABLE PHASE MOVEMENTS, MINIMUM CHANGE DIS-ABLE FOR ALL PEDESTRIAN CHANNELS, AND MIN. FLASH, VOLTAGE MON., AND 24V. MON. LATCH OPTIONS AS DESIRED.			
h	A-31	CH. 3 YELLOW	3Y-A ^3 YEL	M.M.U. CHANNEL ASSIGNMENTS			
i	A-32	CH. 15 GREEN	15G-A OLC GRN	CH. 1 = L/S 1 = ^1 VEH.			
j	A-33	CH. 2 YELLOW	2Y-A ^2 YEL	CH. 2 = L/S 2 = ^2 VEH.			
k	A-34	CH. 1 YELLOW	1Y-A ^1 YEL	CH. 3 = L/S 3 = ^3 VEH.			
m	A-35	CONT. VOLT. MON.	B-5 VOLT. MON.	CH. 4 = L/S 4 = ^4 VEH.			
n	A-36	+24V MON. INH.	B-2	CH. 5 = L/S 5 = ^5 VEH.			
p	A-37	OUT RLY 1 CLSD	J3-3	CH. 6 = L/S 6 = ^6 VEH.			
q	A-38	OUT RLY 2 OPEN	A-31 STOP TIME	CH. 7 = L/S 7 = ^7 VEH.			
r	A-39	CH. 12 WALK	----	CH. 8 = L/S 8 = ^8 VEH.			
s	A-40	CH. 11 WALK	----	CH. 9 = L/S 9 = ^2 PED.			
t	A-41	CH. 9 WALK	----	CH. 10 = L/S 10 = ^4 PED.			
u	A-42	CH. 16 YELLOW	16Y-A OLB YEL	CH. 11 = L/S 11 = ^6 PED.			
v	A-43	CH. 15 YELLOW	15Y-A OLC YEL	CH. 12 = L/S 12 = ^8 PED.			
w	A-44	CH. 13 YELLOW	13Y-A OLA YEL	CH. 13 = L/S 13 = OLAP A			
x	A-45	CH. 4 YELLOW	4Y-A ^4 YEL	CH. 14 = L/S 14 = OLAP B			
y	A-46	CH. 14 GREEN	14G-A OLB GRN	CH. 15 = L/S 15 = OLAP C			
z	A-47	CH. 13 GREEN	13G-A OLA GRN	CH. 16 = L/S 16 = OLAP D			
AA	A-48	(SPARE 1)	B24				
BB	A-49	RESET	B-1				
CC	A-50	CAB. INTLK A	B25				
DD	A-51	CAB. INTLK B	B26				
EE	A-52	CH. 14 YELLOW	14Y-A OLB YRL				
FF	A-53	CH. 16 GREEN	16G-A OLD GRN				
GG	A-54	(SPARE 2)	B27				
HH	A-55	TYPE SELECT	A-20 MMU/CMU SEL.				
	A-56	SHELL GND	LS15-2 EARTH GND.				

MMU PROGRAM CARD

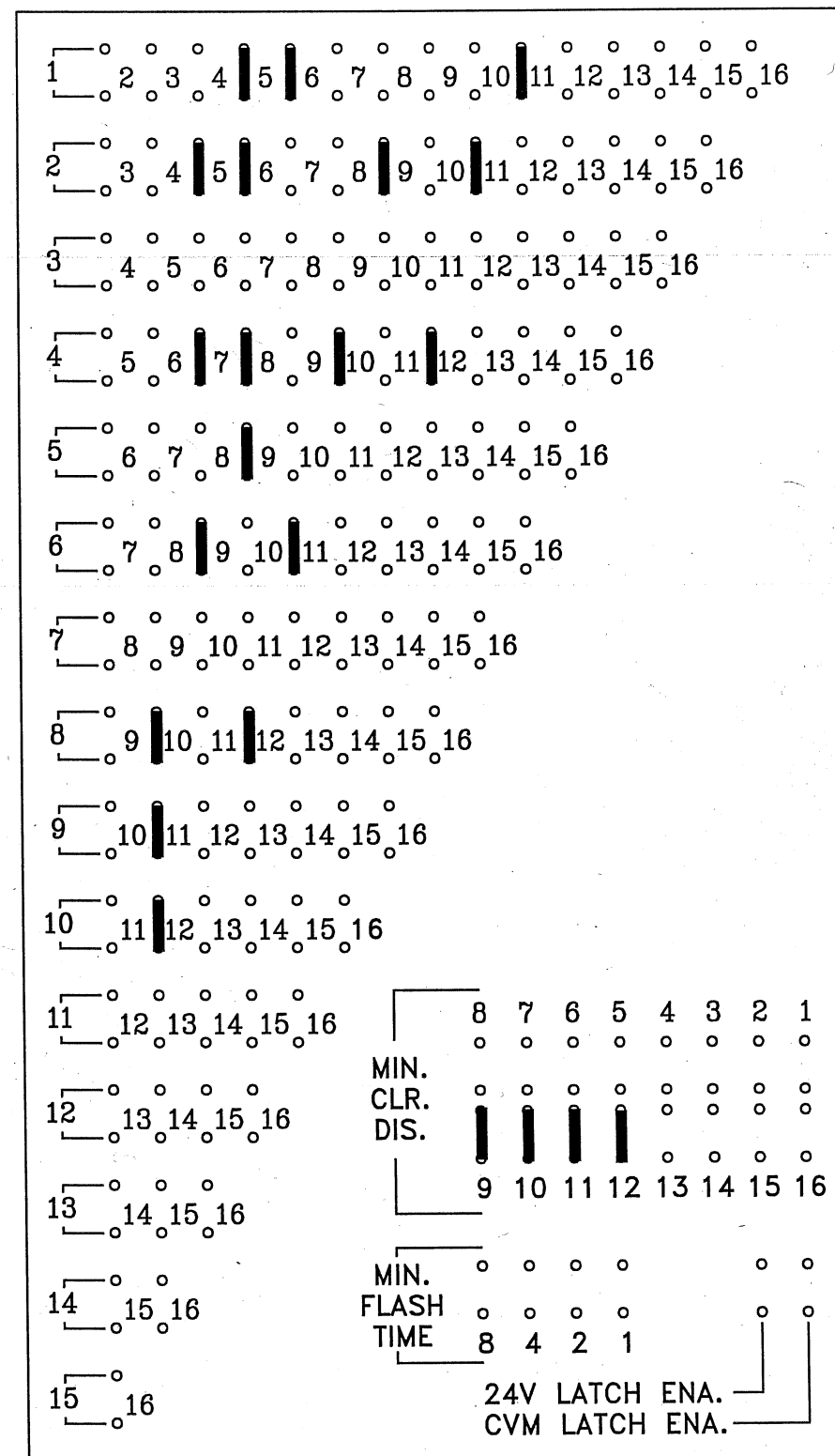

M.M.U. C/C'S AND PROGRAM CARD

DETECTOR RACK 34030G1

①

POWER SUPPLY OR B.I.U.	L3	L1	L7	L5	L11	L9	L15	L13	PMT 5 8	PMT 3 1-6	PGM. CARD
	5-1	1-1	6-1	2-1	∅	4-1	8-3	8-1	<input type="checkbox"/> 2CH OPTICOM/ OPIC	<input type="checkbox"/> 4CH <input type="checkbox"/> 2CH OPTICOM/ OPIC	
	<input type="checkbox"/> 2CH 5-2	<input type="checkbox"/> 2CH 1-2	<input type="checkbox"/> 2CH 6-2	<input type="checkbox"/> 2CH 2-2	<input type="checkbox"/> 2CH ∅	<input type="checkbox"/> 2CH 4-2	<input type="checkbox"/> 2CH ∅	<input type="checkbox"/> 2CH 8-2	CH. C CH. D 4	CH. A CH. B 2-5	
	L4	L2	L8	L6	L12	L10	L16	L14	PMT 6	PMT 4	

J13 C/C 33284G10 DC POWER	J16 C/C 33284G8 EXP. OUTPUTS	J14 C/C 33284G2 LPS 1-8	J18 C/C 33284G9 SYS. OUTPUTS	J15 C/C 33284G3 LPS 9-16	J17 C/C 33284G6 AC POWER	J19 C/C 33284G17 PGM. CARD
---------------------------------	------------------------------------	-------------------------------	------------------------------------	--------------------------------	--------------------------------	----------------------------------

ADDRESS TABLE					
RACK #	JMPR	DET. #'S	RACK #	JMPR	DET. #'S
1	<input type="checkbox"/> <input type="checkbox"/> <input type="checkbox"/>	1-16	5	<input type="checkbox"/> <input type="checkbox"/> <input type="checkbox"/>	65-80
2	<input type="checkbox"/> <input type="checkbox"/> <input type="checkbox"/>	17-32	6	<input type="checkbox"/> <input type="checkbox"/> <input type="checkbox"/>	81-96
3	<input type="checkbox"/> <input type="checkbox"/> <input type="checkbox"/>	33-48	7	<input type="checkbox"/> <input type="checkbox"/> <input type="checkbox"/>	97-112
4	<input type="checkbox"/> <input type="checkbox"/> <input type="checkbox"/>	49-64	8	<input type="checkbox"/> <input type="checkbox"/> <input type="checkbox"/>	113-128

DETECTOR ASSIGNMENTS		
CONT. INPUT	PHASE ASGN.	DETECTOR TYPE
1	1-1	1
2	1-2	1
3	5-1	1
4	5-2	1
5	2-1	1
6	2-2	1
7	6-1	1
8	6-2	1
9	4-1	1
10	4-2	1
11		
12		
13	8-1	1
14	8-2	1
15	8-3	1
16		
17		
18		
19		
20		
21		
22		
23		
24		
25		
26		
27		
28		
29		
30		
31		
32		
33		
34		
35		
36		

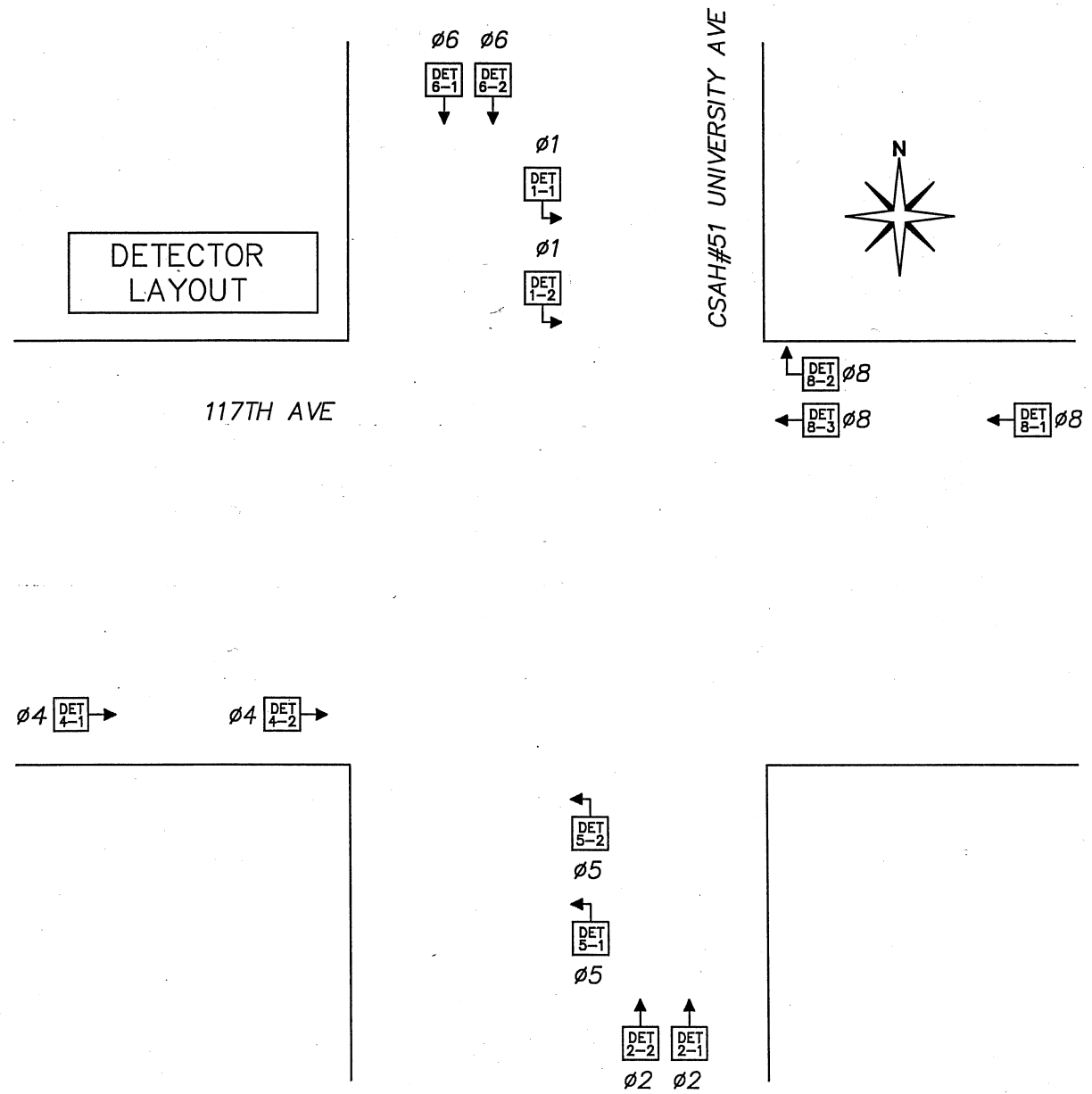

DET. TYPE		DETECTOR RACK PROGRAMMING JUMPERS																											
		SLOT 1/2 ①								SLOT 3/4 ①								SLOT 5/6 ①								SLOT 7/8 ①			
JP1	JP2	JP3	JP4	JP5	JP6	JP7	JP8	JP9	JP10	JP11	JP12	JP13	JP14	JP15	JP16	JP17	JP18	JP19	JP20	JP21	JP22	JP23	JP24	JP25	JP26	JP27	JP28	JP29	JP30
①	TS-1	NO	NO	<input type="checkbox"/>	<input type="checkbox"/>	<input type="checkbox"/>	<input type="checkbox"/>	<input type="checkbox"/>	<input type="checkbox"/>	<input type="checkbox"/>	<input type="checkbox"/>	<input type="checkbox"/>	<input type="checkbox"/>	<input type="checkbox"/>	<input type="checkbox"/>	<input type="checkbox"/>	<input type="checkbox"/>	<input type="checkbox"/>	<input type="checkbox"/>	<input type="checkbox"/>	<input type="checkbox"/>	<input type="checkbox"/>	<input type="checkbox"/>	<input type="checkbox"/>	<input type="checkbox"/>	<input type="checkbox"/>	<input type="checkbox"/>	<input type="checkbox"/>	<input type="checkbox"/>
②	TS-2	YES	YES	<input type="checkbox"/>	<input type="checkbox"/>	<input type="checkbox"/>	<input type="checkbox"/>	<input type="checkbox"/>	<input type="checkbox"/>	<input type="checkbox"/>	<input type="checkbox"/>	<input type="checkbox"/>	<input type="checkbox"/>	<input type="checkbox"/>	<input type="checkbox"/>	<input type="checkbox"/>	<input type="checkbox"/>	<input type="checkbox"/>	<input type="checkbox"/>	<input type="checkbox"/>	<input type="checkbox"/>	<input type="checkbox"/>	<input type="checkbox"/>	<input type="checkbox"/>	<input type="checkbox"/>	<input type="checkbox"/>	<input type="checkbox"/>	<input type="checkbox"/>	<input type="checkbox"/>
③	LM-632T 262-FC	NO	NO	<input type="checkbox"/>	<input type="checkbox"/>	<input type="checkbox"/>	<input type="checkbox"/>	<input type="checkbox"/>	<input type="checkbox"/>	<input type="checkbox"/>	<input type="checkbox"/>	<input type="checkbox"/>	<input type="checkbox"/>	<input type="checkbox"/>	<input type="checkbox"/>	<input type="checkbox"/>	<input type="checkbox"/>	<input type="checkbox"/>	<input type="checkbox"/>	<input type="checkbox"/>	<input type="checkbox"/>	<input type="checkbox"/>	<input type="checkbox"/>	<input type="checkbox"/>	<input type="checkbox"/>	<input type="checkbox"/>	<input type="checkbox"/>	<input type="checkbox"/>	<input type="checkbox"/>
④	MAG.	NO	NO	<input type="checkbox"/>	<input type="checkbox"/>	<input type="checkbox"/>	<input type="checkbox"/>	<input type="checkbox"/>	<input type="checkbox"/>	<input type="checkbox"/>	<input type="checkbox"/>	<input type="checkbox"/>	<input type="checkbox"/>	<input type="checkbox"/>	<input type="checkbox"/>	<input type="checkbox"/>	<input type="checkbox"/>	<input type="checkbox"/>	<input type="checkbox"/>	<input type="checkbox"/>	<input type="checkbox"/>	<input type="checkbox"/>	<input type="checkbox"/>	<input type="checkbox"/>	<input type="checkbox"/>	<input type="checkbox"/>	<input type="checkbox"/>	<input type="checkbox"/>	<input type="checkbox"/>

DETECTOR LOOP
INTERFACE
ASSY. 34040G1

J1
TO DR1: J14
C/C 33284G2

J2
TO DR1: J15
C/C 33284G3

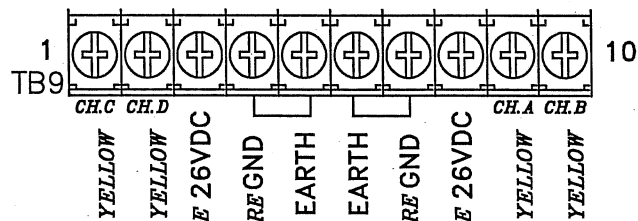
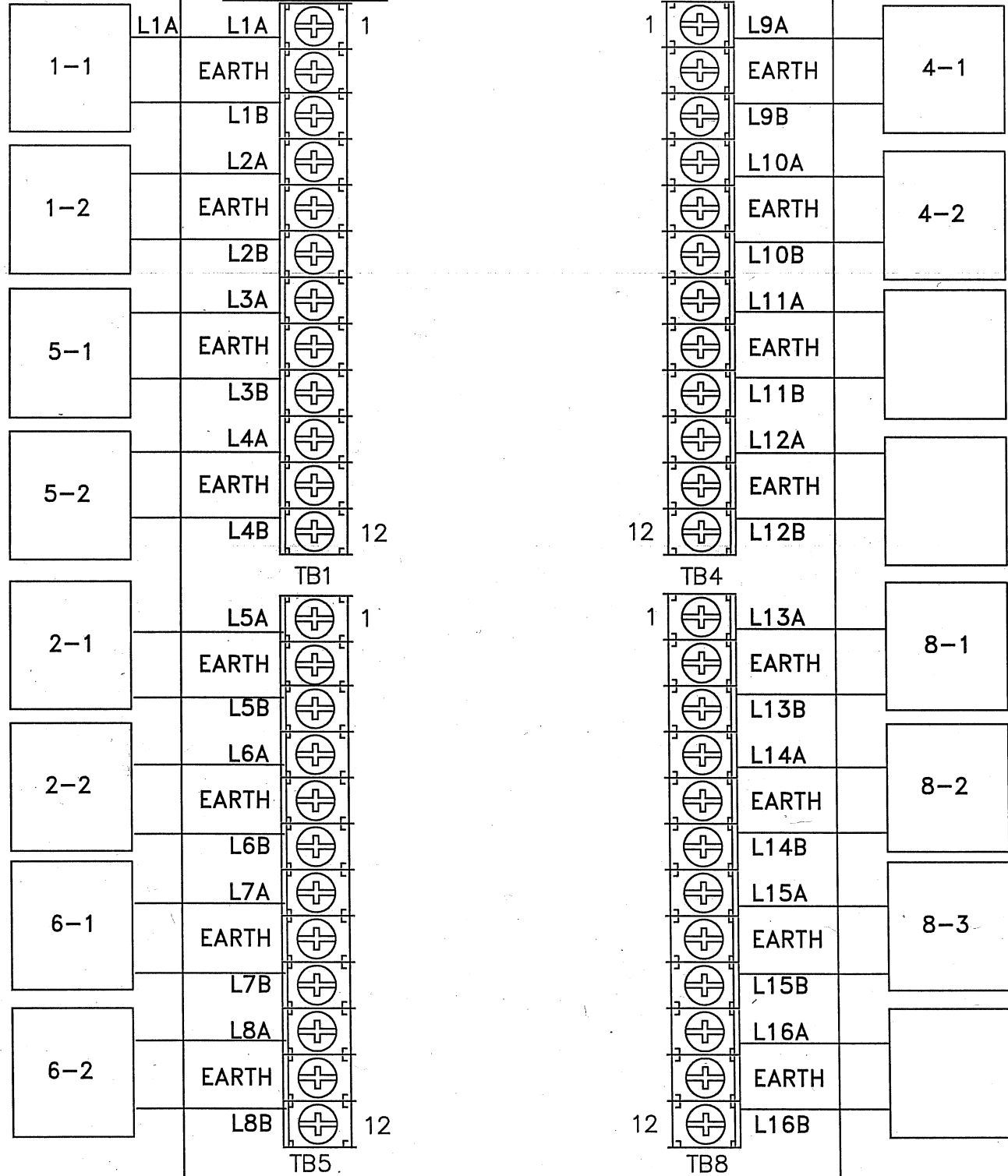

CONNECT EVP DETECTORS HERE

DET. LOOPS 9-16 (J15) C/C 33284G3

PIN	SIGNAL	TO
1	LOOP 9+	LPI2: TB4-1
2	LOOP 9-	LPI2: TB4-3
3	LOOP 10+	LPI2: TB4-4
4	LOOP 10-	LPI2: TB4-6
5	LOOP 11+	LPI2: TB4-7
6	LOOP 11-	LPI2: TB4-9
7	LOOP 12+	LPI2: TB4-10
8	LOOP 12-	LPI2: TB4-12
9	LOOP 13+	LPI2: TB8-1
10	LOOP 13-	LPI2: TB8-3
11	LOOP 14+	LPI2: TB8-4
12	LOOP 14-	LPI2: TB8-6
13	LOOP 15+	LPI2: TB8-7
14	LOOP 15-	LPI2: TB8-9
15	LOOP 16+	LPI2: TB8-10
16	LOOP 16-	LPI2: TB8-12
17	----	
18	----	
19	----	
20	----	

DET. LOOPS 1-8 (J14) C/C 33284G2

PIN	SIGNAL	TO
1	LOOP 1+	LPI1: TB1-1
2	LOOP 1-	LPI1: TB1-3
3	LOOP 2+	LPI1: TB1-4
4	LOOP 2-	LPI1: TB1-6
5	LOOP 3+	LPI1: TB1-7
6	LOOP 3-	LPI1: TB1-9
7	LOOP 4+	LPI1: TB1-10
8	LOOP 4-	LPI1: TB1-12
9	LOOP 5+	LPI1: TB5-1
10	LOOP 5-	LPI1: TB5-3
11	LOOP 6+	LPI1: TB5-4
12	LOOP 6-	LPI1: TB5-6
13	LOOP 7+	LPI1: TB5-7
14	LOOP 7-	LPI1: TB5-9
15	LOOP 8+	LPI1: TB5-10
16	LOOP 8-	LPI1: TB5-12
17	PMT. DET. CH. C	LPI1: TB9-1
18	PMT. DET. CH. D	LPI1: TB9-2
19	KEY PIN	
20	PMT. CH. C/D +26VDC	LPI1: TB9-3
21	PMT. DC GROUND	LPI1: TB9-4,7
22	PMT. CH. A/B +26VDC	LPI1: TB9-8
23	PMT. DET. CH. A	LPI1: TB9-9
24	PMT. DET. CH. B	LPI1: TB9-10
25	----	
26	----	

DET. RACK POWER C/C 34842G5			
P1/ DR: J13	P2/ DR: J17	FUNCTION	TO
1		+12 VDC (DET. POWER)	PB-3
2		+24 VDC (BIU POWER)	PB-2
3		LOGIC GROUND	PB-1
4		EARTH GROUND	PB-9
5		"KEY PIN"	
6		LINE FREQUENCY REF.	PB-5
	1	EARTH GROUND	----
	2	AC LINE	PB-12
	3	AC NEUTRAL	PB-10
	4	LOGIC GROUND	----

EXPANSION OUTPUTS C/C 33284G8		
J16	FUNCTION	TO
17	DET. 17 / PMT. A OUT	MP: B19
18	DET. 18 / PMT. B OUT	MP: B20
19	PMT. C OUT	MP: B17
20	PMT. D OUT	MP: B18

DETECTOR LOOP INTERFACE

DETECTOR RACK 34030G1

POWER SUPPLY OR B.I.U.	L19	L17	L23	L21	L27	L25	L31	L29	PGM. CARD
	\emptyset	\emptyset	\emptyset	\emptyset	\emptyset	\emptyset	\emptyset	\emptyset	
	\square 2CH \emptyset	\square 2CH \emptyset	\square 2CH \emptyset	\square 2CH \emptyset	\square 2CH \emptyset	\square 2CH \emptyset	\square 2CH \emptyset	\square 2CH \emptyset	
	L20	L18	L24	L22	L28	L26	L32	L30	

J13 C/C 33284G10 DC POWER	J16 C/C 33284G8 EXP. OUTPUTS	J14 C/C 33284G2 LPS 1-8	J18 C/C 33284G9 SYS. OUTPUTS	J15 C/C 33284G3 LPS 9-16	J17 C/C 33284G6 AC POWER	J19 C/C 33284G17 PGM. CARD
--	---	--------------------------------------	---	---------------------------------------	---------------------------------------	---

②

ADDRESS TABLE					
RACK #	JMPR	DET. #'S	RACK #	JMPR	DET. #'S
1	\square \square \square	1-16	5	\square \square \square	65-80
2	\square \square \square	17-32	6	\square \square \square	81-96
3	\square \square \square	33-48	7	\square \square \square	97-112
4	\square \square \square	49-64	8	\square \square \square	113-128

DETECTOR ASSIGNMENTS		
CONT. INPUT	PHASE ASGN.	DETECTOR TYPE
1	1-1	1
2	1-2	1
3	5-1	1
4	5-2	1
5	2-1	1
6	2-2	1
7	6-1	1
8	6-2	1
9	4-1	1
10	4-2	1
11		
12		
13	8-1	1
14	8-2	1
15	8-3	1
16		
17		
18		
19		
20		
21		
22		
23		
24		
25		
26		
27		
28		
29		
30		
31		
32		
33		
34		
35		
36		

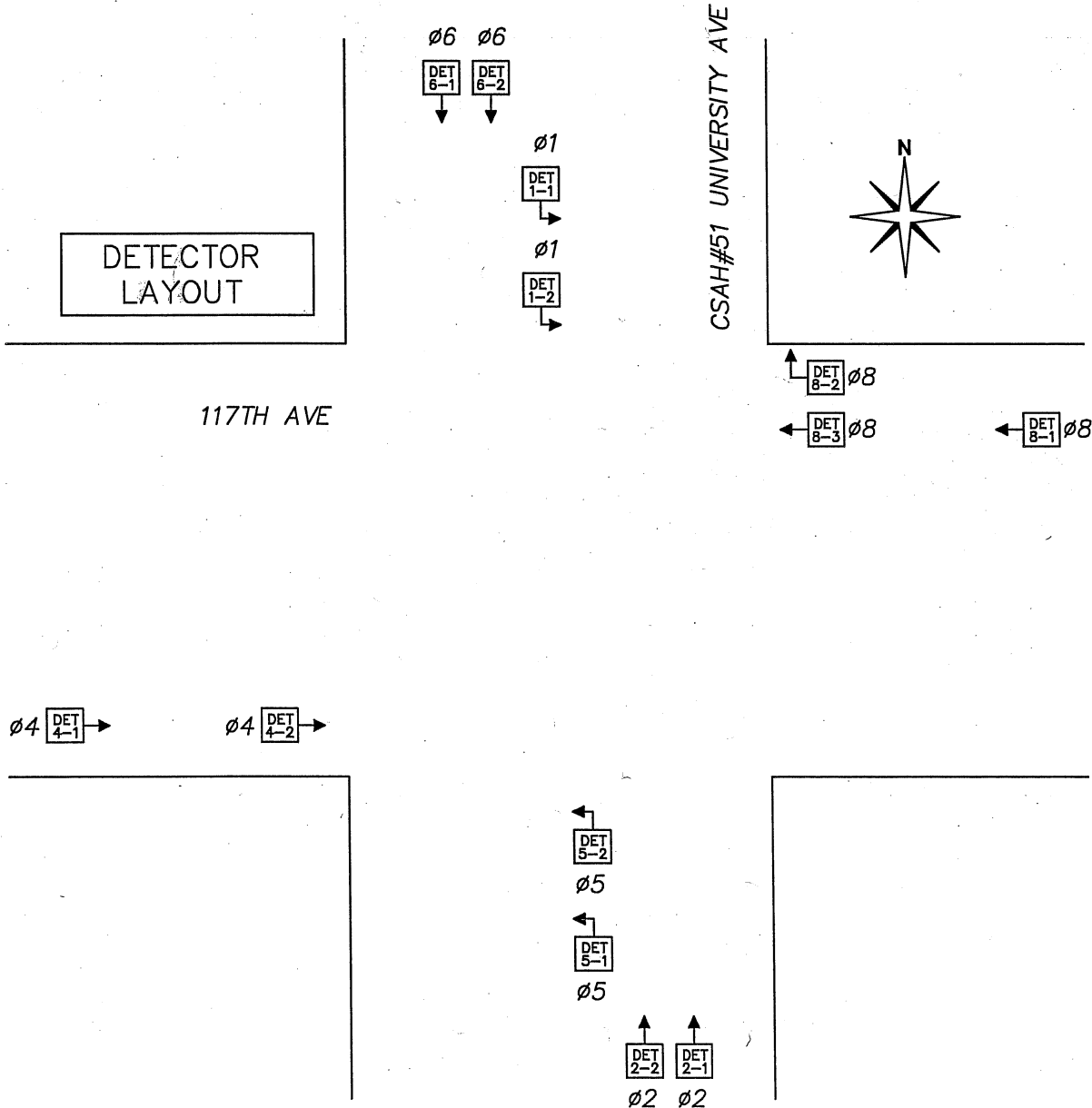

DET. TYPE		DETECTOR RACK PROGRAMMING JUMPERS																													
		SLOT 1/2 ①						SLOT 3/4 ①						SLOT 5/6 ①						SLOT 7/8 ①											
		JP1	JP2	JP3	JP4	JP5	JP6	JP7	JP8	JP9	JP10	JP11	JP12	JP13	JP14	JP15	JP16	JP17	JP18	JP19	JP20	JP21	JP22	JP23	JP24	JP25	JP26	JP27	JP28	JP29	JP30
①	TS-1	NO	NO	\circ	\circ	\circ	\circ	\circ	\circ	\circ	\circ	\circ	\circ	\circ	\circ	\circ	\circ	\circ	\circ	\circ	\circ	\circ	\circ	\circ	\circ	\circ	\circ	\circ	\circ	\circ	
②	TS-2	YES	YES	\circ	\circ	\circ	\circ	\circ	\circ	\circ	\circ	\circ	\circ	\circ	\circ	\circ	\circ	\circ	\circ	\circ	\circ	\circ	\circ	\circ	\circ	\circ	\circ	\circ	\circ	\circ	
③	LM-632T 262-FC	NO	NO	\circ	\circ	\circ	\circ	\circ	\circ	\circ	\circ	\circ	\circ	\circ	\circ	\circ	\circ	\circ	\circ	\circ	\circ	\circ	\circ	\circ	\circ	\circ	\circ	\circ	\circ		
④	MAG.	NO	NO	\circ	\circ	\circ	\circ	\circ	\circ	\circ	\circ	\circ	\circ	\circ	\circ	\circ	\circ	\circ	\circ	\circ	\circ	\circ	\circ	\circ	\circ	\circ	\circ	\circ	\circ		

DETECTOR LOOP
INTERFACE
ASSY. 34040G1

J1
TO DR1: J14
C/C 33284G2

J2
TO DR1: J15
C/C 33284G3

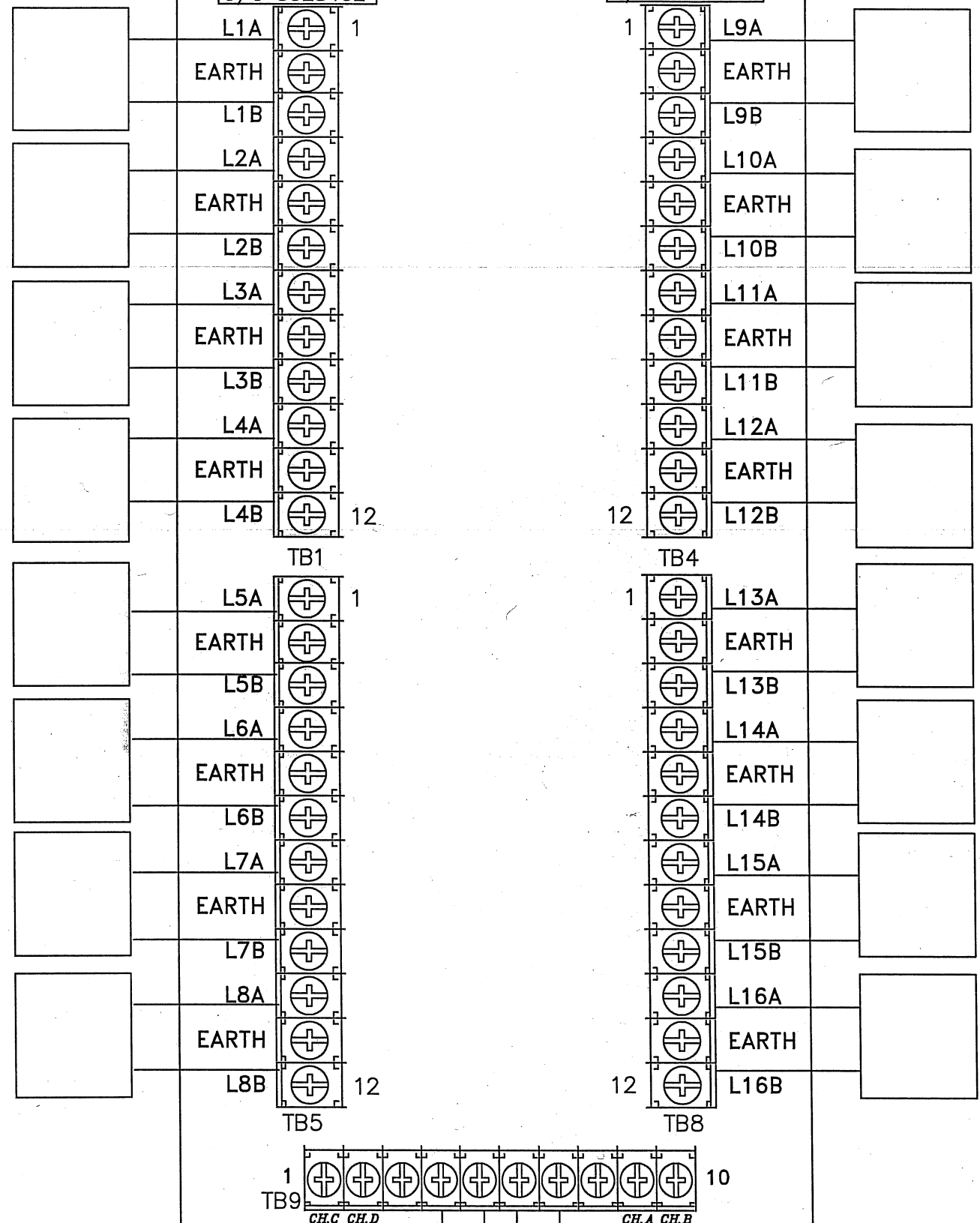

DET. LOOPS 9-16 (J15) C/C 33284G3

PIN	SIGNAL	TO
1	LOOP 9+	LPI2: TB4-1
2	LOOP 9-	LPI2: TB4-3
3	LOOP 10+	LPI2: TB4-4
4	LOOP 10-	LPI2: TB4-6
5	LOOP 11+	LPI2: TB4-7
6	LOOP 11-	LPI2: TB4-9
7	LOOP 12+	LPI2: TB4-10
8	LOOP 12-	LPI2: TB4-12
9	LOOP 13+	LPI2: TB8-1
10	LOOP 13-	LPI2: TB8-3
11	LOOP 14+	LPI2: TB8-4
12	LOOP 14-	LPI2: TB8-6
13	LOOP 15+	LPI2: TB8-7
14	LOOP 15-	LPI2: TB8-9
15	LOOP 16+	LPI2: TB8-10
16	LOOP 16-	LPI2: TB8-12
17	----	
18	----	
19	----	
20	----	

DET. LOOPS 1-8 (J14) C/C 33284G2

PIN	SIGNAL	TO
1	LOOP 1+	LPI1: TB1-1
2	LOOP 1-	LPI1: TB1-3
3	LOOP 2+	LPI1: TB1-4
4	LOOP 2-	LPI1: TB1-6
5	LOOP 3+	LPI1: TB1-7
6	LOOP 3-	LPI1: TB1-9
7	LOOP 4+	LPI1: TB1-10
8	LOOP 4-	LPI1: TB1-12
9	LOOP 5+	LPI1: TB5-1
10	LOOP 5-	LPI1: TB5-3
11	LOOP 6+	LPI1: TB5-4
12	LOOP 6-	LPI1: TB5-6
13	LOOP 7+	LPI1: TB5-7
14	LOOP 7-	LPI1: TB5-9
15	LOOP 8+	LPI1: TB5-10
16	LOOP 8-	LPI1: TB5-12
17	PMT. DET. CH. C	LPI1: TB9-1
18	PMT. DET. CH. D	LPI1: TB9-2
19	KEY PIN	
20	PMT. CH. C/D +26VDC	LPI1: TB9-3
21	PMT. DC GROUND	LPI1: TB9-4,7
22	PMT. CH. A/B +26VDC	LPI1: TB9-8
23	PMT. DET. CH. A	LPI1: TB9-9
24	PMT. DET. CH. B	LPI1: TB9-10
25	----	
26	----	

DET. RACK POWER C/C 34842G5			
P1/ DR: J13	P2/ DR: J17	FUNCTION	TO
1		+12 VDC (DET. POWER)	PB-3
2		+24 VDC (BIU POWER)	PB-2
3		LOGIC GROUND	PB-1
4		EARTH GROUND	PB-9
5		"KEY PIN"	
6		LINE FREQUENCY REF.	PB-5
	1	EARTH GROUND	----
	2	AC LINE	PB-12
	3	AC NEUTRAL	PB-10
	4	LOGIC GROUND	----

EXPANSION OUTPUTS C/C 33284G8		
J16	FUNCTION	TO
17	DET. 17 / PMT. A OUT	MP: B19
18	DET. 18 / PMT. B OUT	MP: B20
19	PMT. C OUT	MP: B17
20	PMT. D OUT	MP: B18

DETECTOR LOOP INTERFACE

B.I.U	DET	PH	F	DET	DLY	EXT	DET	PH	F	DET	DLY	EXT	DET	PH	F	DET	DLY	EXT	DET	PH	F	DET	DLY	EXT	EVP	PH	POLE #	CONT CH #
	CH 1	1		1-1			CH 5	2		2-1			CH 9	4		4-1			CH 13	8		8-1			CH 1	1-6	3	3
	CH 2	1		1-2			CH 6	2		2-2			CH 10	4		4-2			CH 14	8		8-2			CH 2	2-5	1	4
	CH 3	5		5-1			CH 7	6		6-1			CH 11						CH 15	8		8-3			CH 3	8	4	5
	CH 4	5		5-2			CH 8	6		6-2			CH 12						CH 16						CH 4	4	2	6

B.I.U	DET	PH	F	DET	DLY	EXT	DET	PH	F	DET	DLY	EXT	DET	PH	F	DET	DLY	EXT	DET	PH	F	DET	DLY	EXT				
	CH 17						CH 21						CH 25						CH 29									
	CH 18						CH 22						CH 26						CH 30									
	CH 19						CH 23						CH 27						CH 31									
	CH 20						CH 24						CH 28						CH 32									